

Brand NEW for '48

LIGHT DUTY*
SERIES F1-F2-F3-F4
Gross Weight Ratings up to 10,000 lbs.
Nominal Ratings up to One Ton

FORD *Bonus Built* **TRUCKS**

BUILT STRONGER TO LAST LONGER

*OTHER CATALOGS: HEAVY DUTY
SERIES F-5 and F-6, G.V.W. up to
16,000 lbs.—EXTRA HEAVY DUTY
SERIES F-7 and F-8, G.V.W. up to
21,500 lbs.

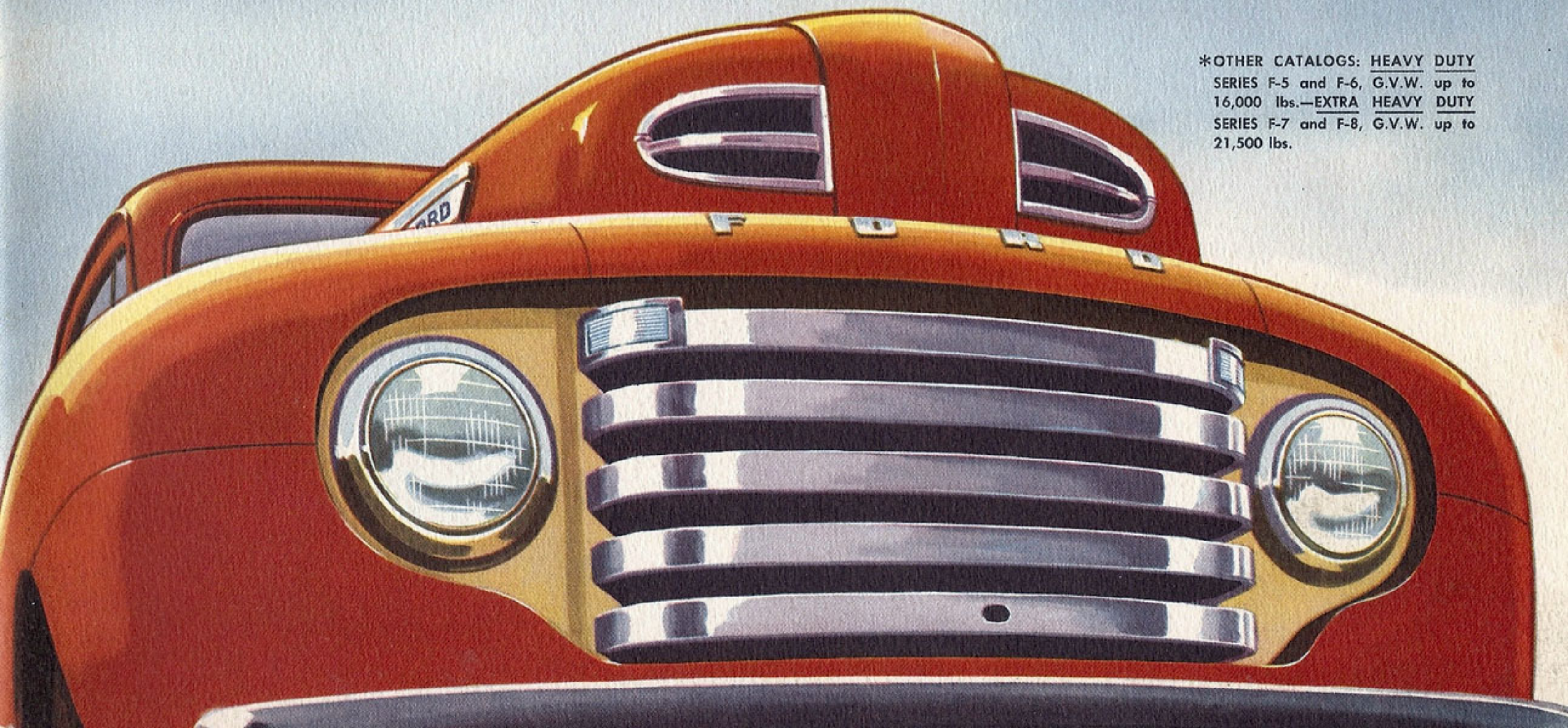

NEW, NEW, BRAND NEW

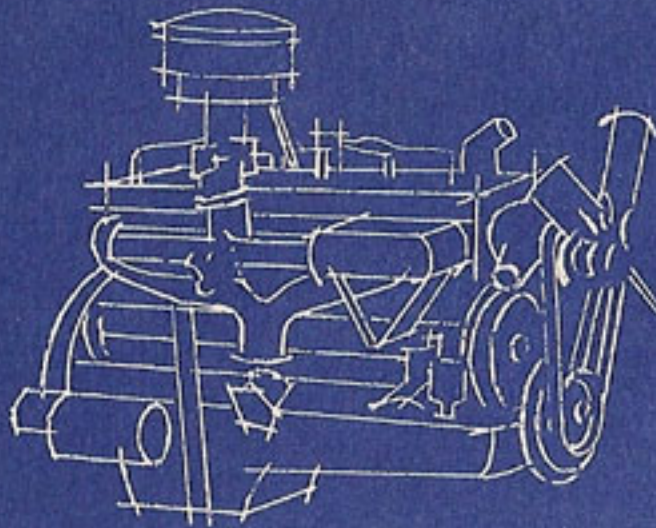

NEW ENGINES

For '48 Ford offers three rugged new truck engines; a brand new 95 H.P. Six and two new, lusty V-8 engines developing 100 and 145 horsepower. The new Rouge 226 Truck Six illustrated is truck-designed, truck-built, from drafting board to final assembly.

NEW MODELS

Five new truck models enter the Ford all-star line-up for '48. Three new light duty models bracket the 3/4 and 1 ton field. Two new BIG JOBS, biggest Ford Trucks ever built, carry gross weight ratings up to 21,500 lbs.

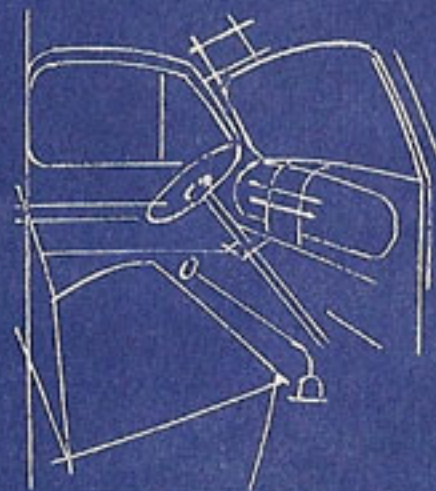
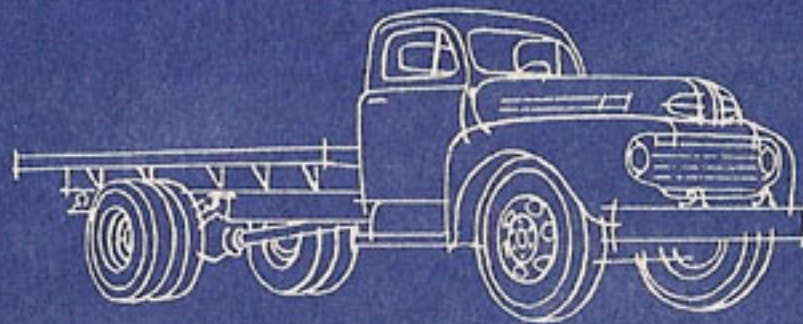

NEW CAB—A new Million Dollar Ford Truck cab gives drivers Living Room comfort. New coach-type seat. New cab suspension insulates cab from vibration, noise and frame weave. More leg, head and elbow room. New picture window visibility. New Spiralounge floating seat available. New 3-way air control, including Fresh Air Intake Heater at extra cost.

NEW STYLING

Here's the truck with the "last longer" look! The new Ford Truck styling with recess-sheltered lights and grille is an outward badge of the many new engineering ideas introduced in the New Ford Bonus Built Truck design for '48.

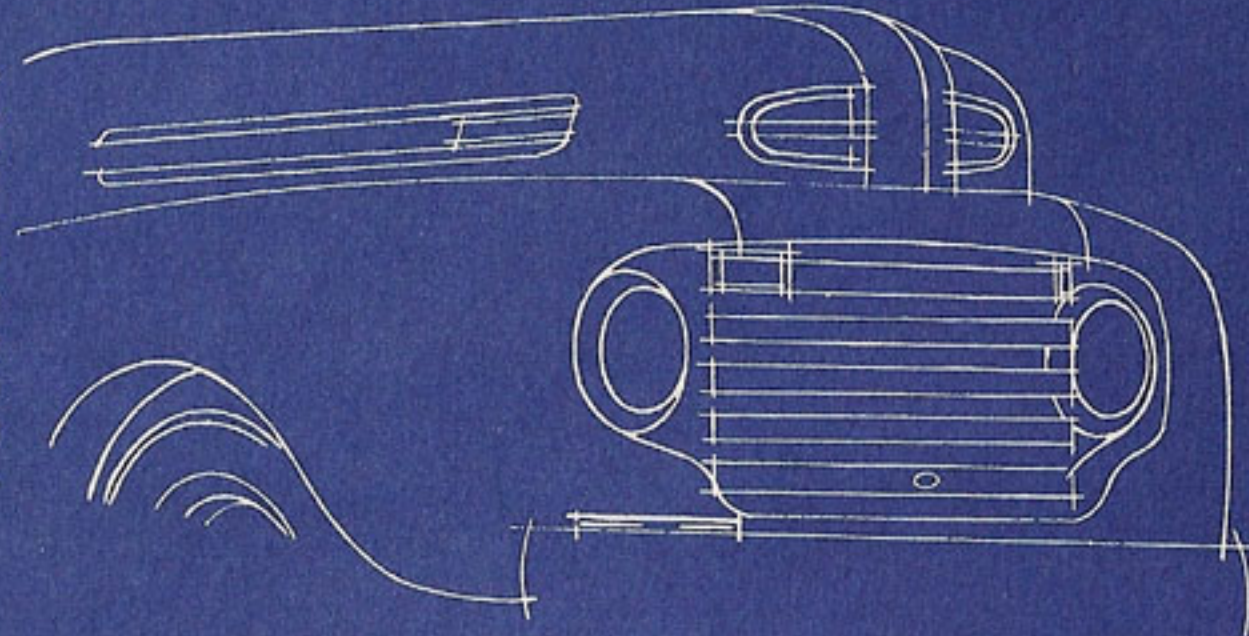

A GALAXY OF NEW FORD ENGINEERING IDEAS PENT-UP BY WAR-BORN CONDITIONS NOW AVAILABLE IN THE NEW FORD BONUS BUILT TRUCKS FOR '48

Millions of Ford Trucks have been built and sold in the past 30 years. But never has there been a single model which has had as big an edge over its predecessor model in newness and in engineering originality, as the new, post-war Fords. For '48, Ford Bonus Built Trucks are brand new, through and through. Their newness reflects the "we're going places" spirit of the Ford Motor Company. New Ford Bonus Built Trucks for '48 offer new styling, new engines, new models, new driver comfort, new service accessibility, new advancements throughout.

COPYRIGHT 1947—FORD MOTOR COMPANY, DEARBORN, MICH. ALL RIGHTS RESERVED.

STYLING	1947
ENGINES	1947
MODELS	1947

FROM THE MIGHTY ROUGE



FROM TRUCK HEADQUARTERS

Bonus* Built

THE AMAZING RESULT OF AN ENGINEERING PRINCIPLE THAT ASSURES
WIDER TRUCK USE, LONGER TRUCK LIFE

... and ONLY Ford Trucks Have It!

BONUS BUILT FRAMES HAVE EXTRA STRENGTH

Ford frames are built with a sinewy extra strength that can take punishment and then come back for more. Stock thicknesses, side rail depths, and cross members are engineered to provide extra strength in all models . . . excess weight in none.

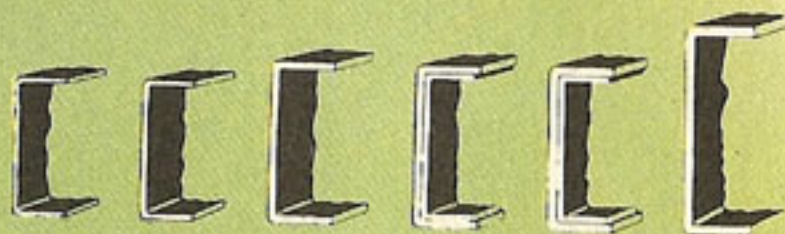

BONUS BUILT AXLES ARE EXTRA TOUGH

Ford front axles can be twisted cold, five complete turns, without evidence of fracture. Extra toughness in all Ford front and rear axle parts has made Ford the favorite on construction jobs, in logging operations, wherever trucks must take hard abuse. There are more Ford Trucks in use today than any other make.

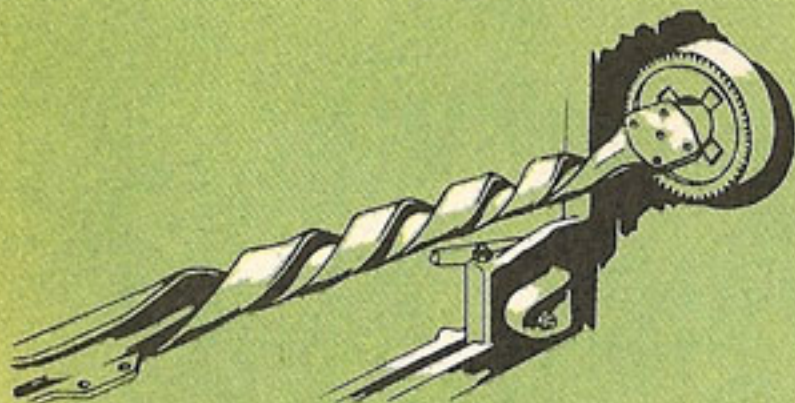

BONUS BUILT CRANKSHAFTS HAVE WORK RESERVES

In torque tests, the Rouge 239 crankshaft is given a twist both ways which exceeds by many times the greatest calculated service stress it will ever have to stand. This means that the crankshaft, like all other Ford Truck working parts, has Bonus Built work reserves to do its rated job . . . and more!

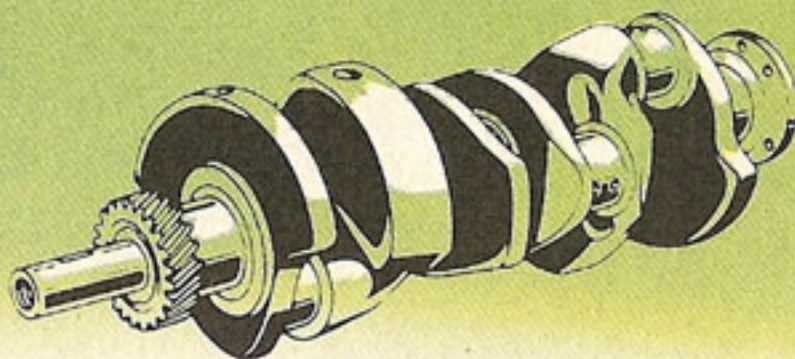

BONUS BUILT PROPELLER SHAFTS ARE REALLY RUGGED

Ford Bonus Built propeller shafts will handle more than twice the torque the engine can deliver through the transmission in low or reverse gear. Built-in extra strength resists shock loads imposed by sudden application of hand brake or clutch. The result—big work reserves for longer life.

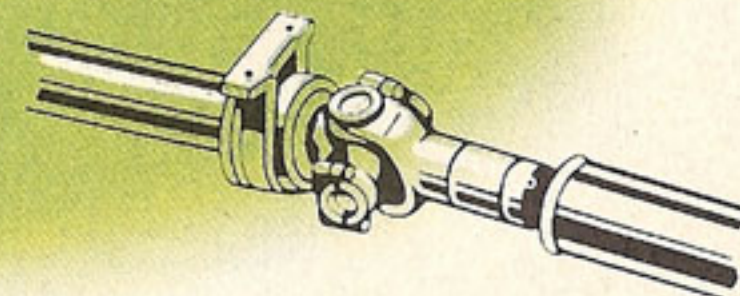

Ford Trucks are built not just strong enough . . . but *Bonus Built* for extra strength in every vital part.

This extra strength provides *work reserves* that pay off in two important ways:

First, these *work reserves* give Ford Trucks a greater *range of use* by permitting them to handle loads beyond the normal call of duty. Ford Trucks are not limited to doing one single, specific job.

Second, these same *work reserves* permit Ford Trucks to relax on the job . . . to do their jobs easier, with less strain and less wear. Thus, Ford Trucks *last longer* because they work *easier*.

Yes, Ford Trucks are *Bonus Built* . . . *Built stronger to last longer*. See the Bonus Built Features of today's great new Ford Trucks. Then you'll know why Ford Trucks give their owners wider use and longer life. Proof? There are more Ford Trucks in use today than any other make!

* Webster's Dictionary Definition of word "BONUS":
"Something given in addition to what is usual or strictly due."

YOUR CHOICE OF OVER 115 NEW FORD CHASSIS-BODY COMBINATIONS, HALF-TON THROUGH 3 TONS

Ford Trucks are Bonus Built TO LAST LONGER!

CASH IN ON LONGER FORD TRUCK LIFE IN THESE IMPORTANT WAYS

CUT OWNERSHIP COSTS PER YEAR



Simple arithmetic shows that Ford Trucks which last up to 19.6% longer, cut ownership (depreciation) costs up to 19.6% per year. On a purchase price of \$1,000 for example, cost of ownership savings are up to \$196 over the full life of a Ford Truck.

BOLSTER TRADE-IN VALUE

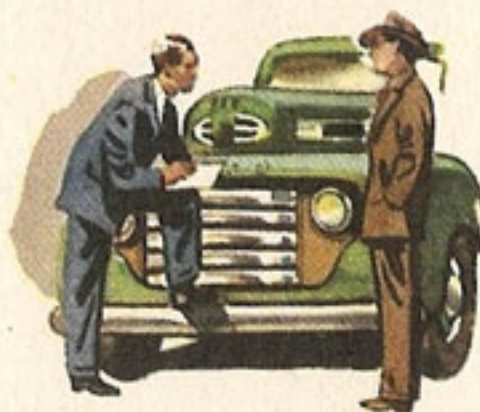

The used truck buyer looks for unused mileage. Because Ford Trucks last up to 19.6% longer, it stands to reason they offer more unused mileage at any given age. The result: great used-truck sales appeal and high trade-in values.

SAVE MONEY ON REPAIRS



Longer truck life is evidence of greater Ford durability and less frequent repairs. What's more, large-scale Ford production keeps parts costs low. Service facilities "just around the corner everywhere", help cut maintenance costs.

KEEP LOST TIME LOSSES DOWN

Greater reliability is an important by-product of Ford long-life truck design. Ford reliability means less time lost on the route—fewer trips missed. Ford Truck owners make more money by keeping lost time losses down.



CASH IN WITH FORD Bonus Built TRUCKS ...IN EVERY WAY THAT COUNTS!

Millions of dollars could be saved by truck users if they had guiding proof as to what truck was best for the job. And there is such proof! Positive proof! It is based on the logic that in the cold-blooded trucking business a truck must produce or perish. If it can't perform, it is fired! If it is uneconomical, it is retired. Only the fittest survive! And because Ford Trucks survive up to 19.6% longer, it stands to reason. Ford Trucks are fittest. Ford Trucks are fittest in performance, in thrift, in reliability . . . in every way that counts.

Certified Proof!

**LIFE INSURANCE EXPERTS PROVE THAT
FORD TRUCKS LAST
UP TO 19.6% LONGER!**

Ford Life Expectancy up to 19.6% More



Life expectancy of a Ford Truck is greater than that of any one of the four other truck sales leaders. It is up to 19.6% or 1.67 years more. Ford Truck average life expectancy is 10.18 years.

Up to 38% More Fords Survive to Age of 10



The percentage of Ford Trucks still in use at the end of 10 years exceeds that of any one of the four other truck sales leaders. Up to 38% more Fords are still going strong at the 10-year mark.

Scrappage of Others up to 35% Higher



Fewer Ford Trucks are scrapped between age 4 and age 12. Scrappage for the "other four" is up to 35% higher. This proves Ford establishes its advantage in the prime of life . . . not as an aged reserve vehicle.

FORD TRUCK LIFE ADVANTAGE OVER THE OTHER FOUR SALES LEADERS

THE LIFE EXPECTANCY OF A FORD TRUCK IS:

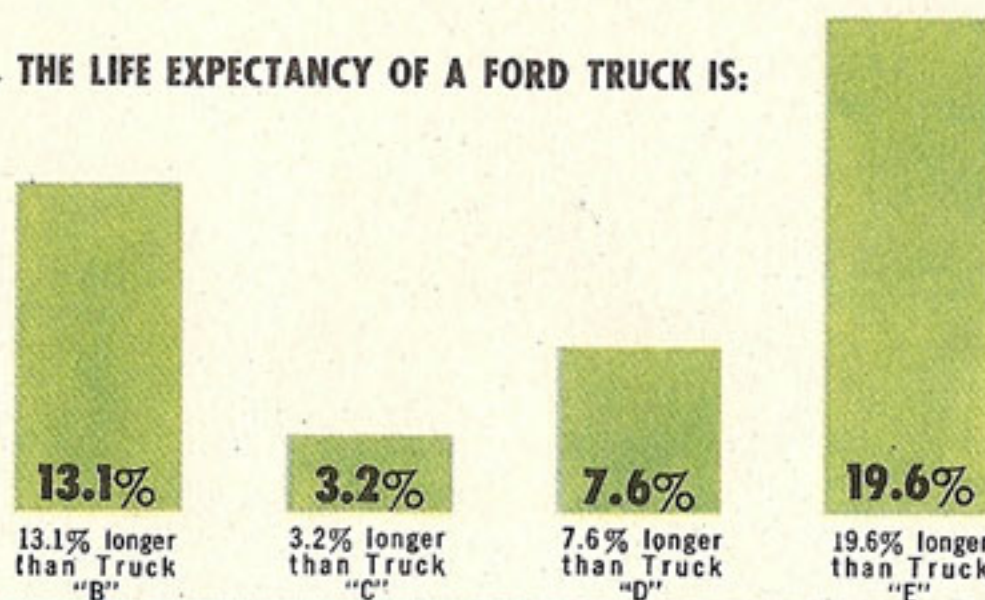

For proof that Ford Trucks last longer, the Ford Motor Company went to the world's biggest "proving grounds" . . . the millions of trucks serving 48 states. For unbiased figures it went to Wolfe, Corcoran and Linder, leading New York life insurance actuaries. The result? Life expectancy tables for trucks, based on the same scientific methods used by insurance companies in figuring life insurance rates. Embracing every-truck registered among the 5 sales leaders from 1933 to 1941, this life expectancy study proved that Ford Bonus Built construction pays off in longer truck life . . . up to 19.6% longer than the life of the other 4 sales leaders.

PROOF!

4,967,000 TRUCKS
STRONG

CERTIFIED!

BY INDEPENDENT LIFE
INSURANCE EXPERTS

OFFICIAL ACTUARIAL CERTIFICATE

Based on the application of sound and accepted actuarial methods to the actual experience as measured by truck registrations, we hereby certify that, in our opinion, the accompanying table fairly presents the relative life expectancy of the trucks involved.

WOLFE, CORCORAN AND LINDER
Life Insurance Actuaries, New York, N. Y.

SERIES F-1

Max. Gross Vehicle Weight: 4,700 lbs.

Nominal Tonnage Rating: Half-Ton

6½ FT. PICKUP

MASTER OF A THOUSAND-AND-ONE LIGHT DELIVERY JOBS

LONG WEARING ALL-STEEL FLOOR has hardwood subfloor to minimize denting. Skid strips stamped in, can't work loose.

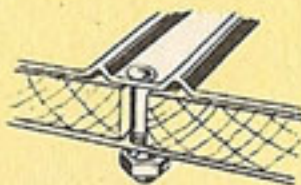

NEW HYPOID AXLE, semi-floating type. Husky pinion. Quiet running. New, exclusive, integral housing fully exposes differential for easy maintenance. Shafts removable from wheel end.

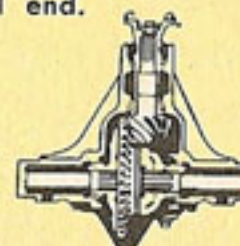

NO-CATCH ROLLED-EDGE FLARE-BOARDS strengthen body, offer better sliding surface for objects loaded from side. Stake pockets permit mounting of up-rights for special sides and tops.



NEW MILLION DOLLAR CAB features new 3-way air control. New coach-type seat for comfort. New, Level Action cab mounting to frame for longer cab life. New Spiralounge floating seat with variable-rate spiral coil spring and hydraulic shock absorber available for comfort-plus.

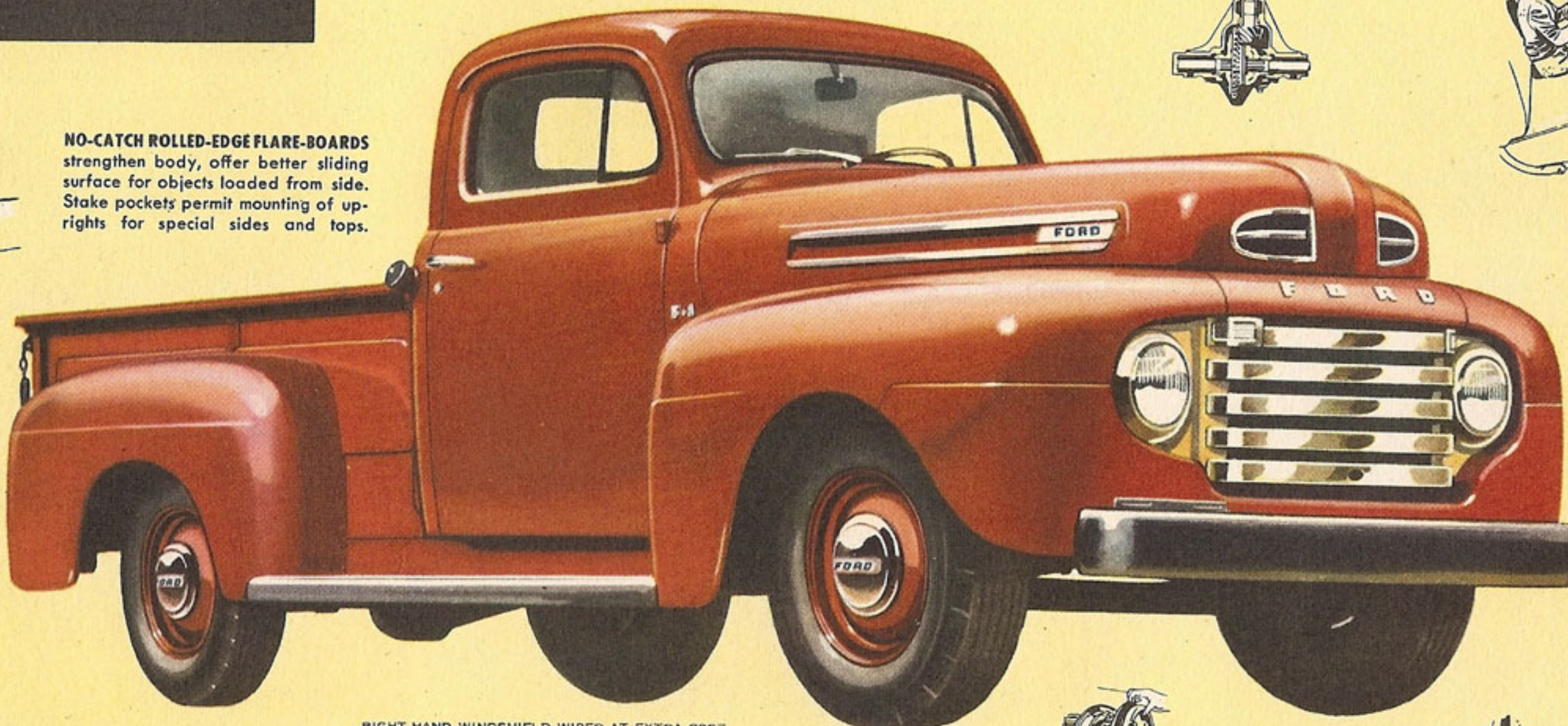

TAILGATE strengthened with tapered truss-type rolled edge. Anti-rattle drop-chains hold tailgate flush with floor or let it swing all the way down.

RIGHT-HAND WINDSHIELD WIPER AT EXTRA COST.

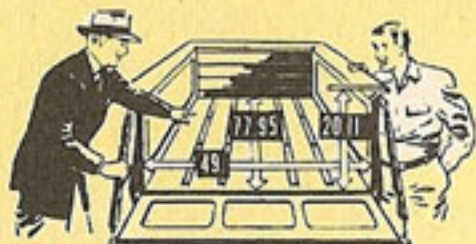

BIG BODY handles standard four feet wide building materials, long enough to carry average door. Capacity of 45 cu. ft. makes it one of biggest Pickups in the half-ton field.

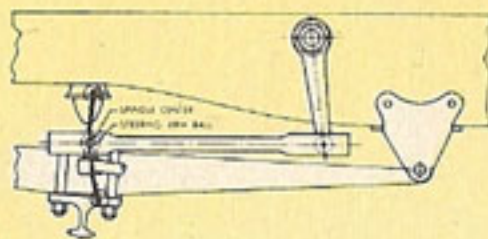

NEW FORE AND AFT STEERING for greater stability, more uniform response under variable conditions. Drag link and forward shacked springs follow similar arcs. Better steering geometry, easier control.

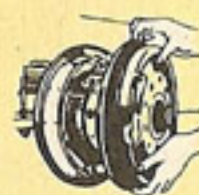

REMOVABLE BRAKE DRUMS simplify maintenance. Drum can be bought separately from hub for replacement.

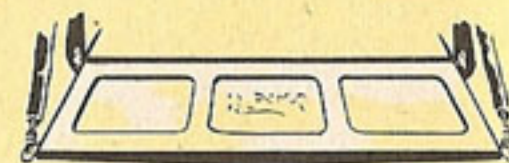

The 45 cu. ft. body capacity makes the F-1 Pickup one of the biggest in the half-ton field. Big load width of over four feet gives the F-1 Pickup an amazing range of use. The new Rouge 226 Truck Six has performance galore. With standard 3.73 to 1 axle, 6.50-16 tires, gross load of 4,700 lbs. including 1,450 lbs. payload, it pulls a 10% smooth concrete grade in high, better than 30% grade in first. Engine speed at 35 m.p.h. is an economical 1,600 r.p.m. An optional 4.27 to 1 rear axle ratio steps up pulling ability approximately 14%. Truck operators choose the 3.73 rear axle ratio for economy, the 4.27 axle ratio for extra pulling ability.

ENGINEERING HIGHLIGHTS—NEW F-1 PICKUP

NEW ROUGE 226 TRUCK SIX—New, longer 4-ring Flightlight pistons save oil—Main and connecting rod bearings are replaceable-type—Series-flow cooling with thermostatic control—Alloy exhaust valve seat inserts give longer wear—Improved intake manifold for higher efficiency—New Loadomatic spark control for more power, more economy—New Rouge 239 Truck V-8 Available. **CHASSIS**—New Feather-Foot brakes—for true and easy stopping—Needle bearing steering eases control—Flat tube and fin radiator for greater durability—New airplane-type shock absorbers, front and rear—Gyro-Grip clutch multiplies grip with increased speed.

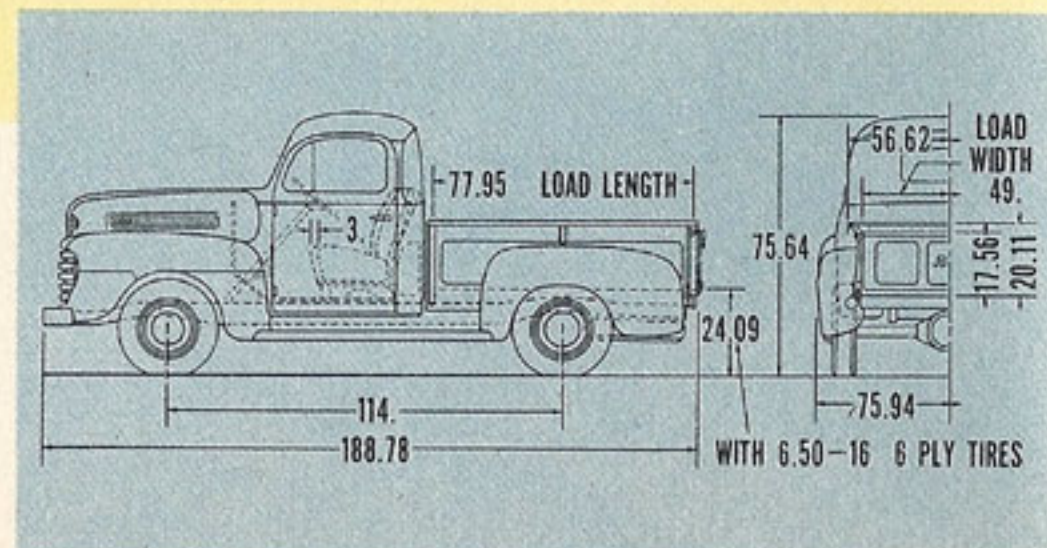

SEALING-IN THE "COUNTER FRESHNESS" OF YOUR GOODS

SERIES F-1

Max. Gross Vehicle Weight: 4,700 lbs.
Nominal Tonnage Rating: Half-Ton

8 FT. PANEL

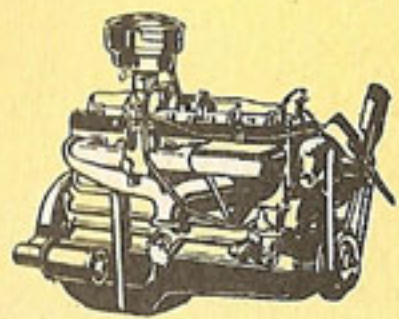

A true-truck engine from crankcase up. 95 horsepower. New oil-saver features. New gas-saver features. New advancements throughout.

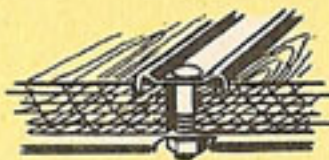

SOLID PLYWOOD FLOOR with steel skid strips. Stronger, more durable, offers better seal against dust and fumes.

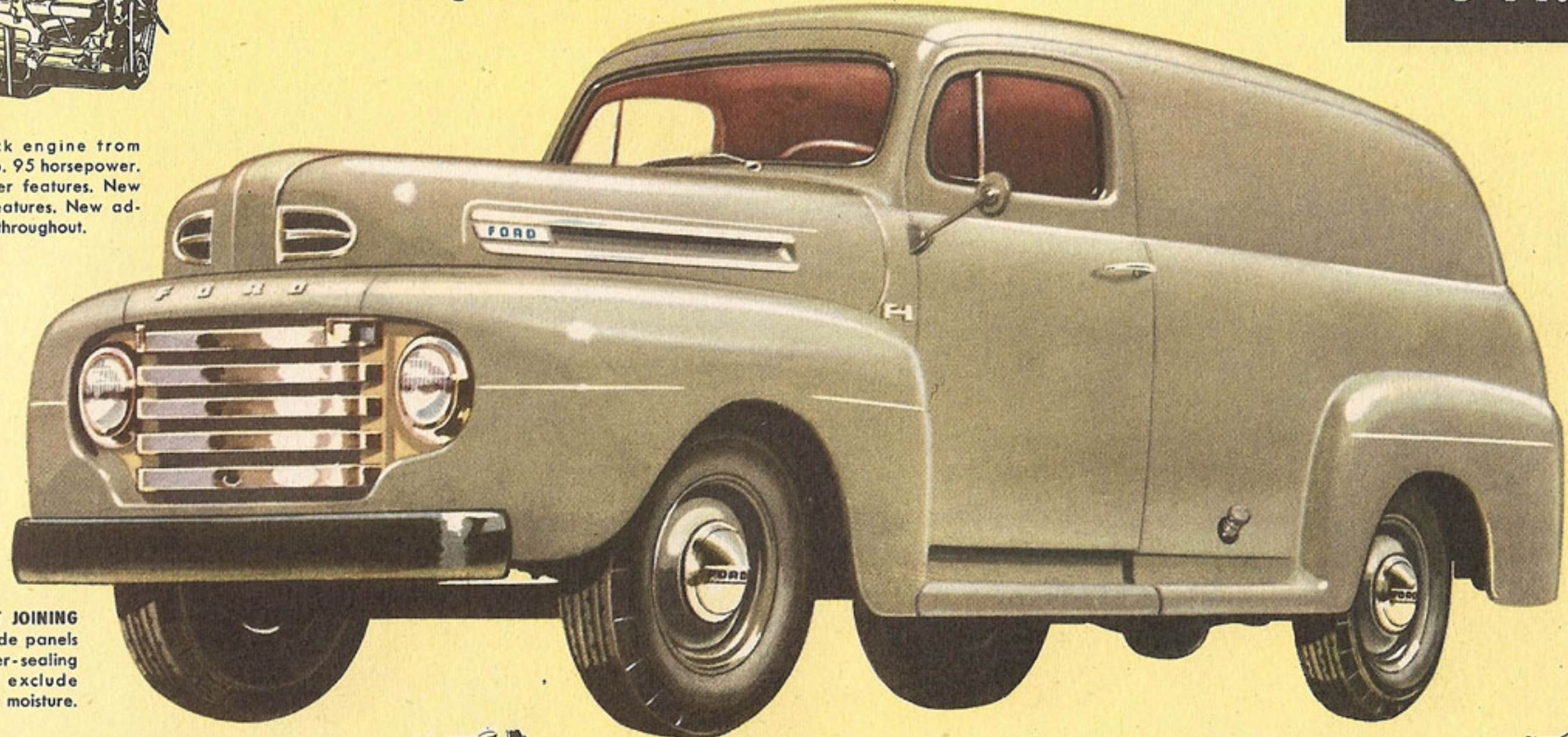

ALL-STEEL WELDED BODY, heavy-gage side and roof panels, sturdy steel frame with reinforcing brackets. Bonus Built construction keeps joints anchored, doors in line, maintains dust-tight seal.

SEALED-TIGHT JOINING of floor to side panels with weather-sealing strips helps exclude dust, fumes, moisture.



BUCKET-TYPE DRIVER'S SEAT, comfortably cushioned, designed for proper driving posture, adjustable, permits easy access to load area.



TWO-POSITION DOOR CHECKS hold rear doors to either full or 90° opening. Weather-sealed doors are hinged to rugged one-piece steel door frame.



EXTRA LENGTH alongside driver's seat accommodates merchandise up to 11½-feet long. Ample load width of 5 feet.

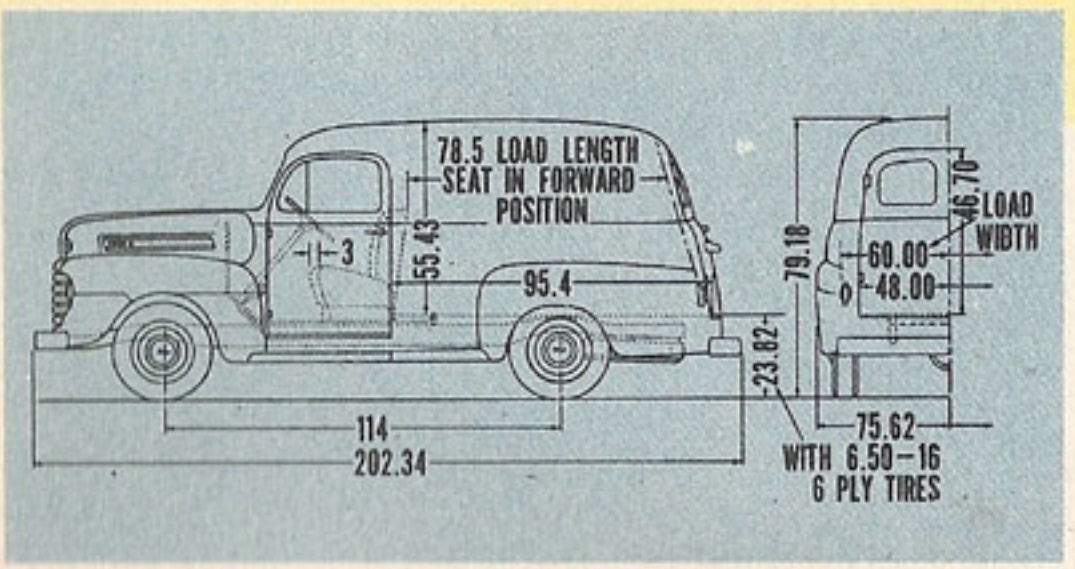

The handsome F-1 Panel, sealed against dust and fumes, offers a total capacity of 160.3 cu. ft. This spacious roominess is ample for most light delivery work requiring fully enclosed bodies. Interior height is 55.4 in., width 60 in., length back of seat 95.4 in., length alongside driver's seat 138.75 in. Curb weight is about 3,485 lbs. Payload capacity on 6.50-16 tires is 1,215 lbs. Engine speed at 35 m.p.h. is economical 1,600 r.p.m. with the standard 3.73 to 1 Economy Ratio. With full load, the F-1 Panel will pull a 10% smooth concrete grade in high gear. Optional 4.27 to 1 Power Ratio steps up pulling ability approximately 14%.

ENGINEERING HIGHLIGHTS—NEW F-1 PANEL

NEW ROUGE 226 TRUCK SIX—New longer 4-ring Flightlight pistons save oil—Replaceable-type main and connecting rod bearings—Series-flow cooling with thermostatic control—Alloy exhaust valve seat inserts give longer wear. Improved intake manifold for higher efficiency—New Loadomatic spark control for more power, more economy. New Rouge 239 Truck V-8 available. **CHASSIS**—New Feather-Foot brakes for easy stopping—New removable brake drums facilitate servicing—Needle-bearing steering eases control—Flat tube and fin radiator for greater durability—Gyro-Grip Clutch multiplies grip with increased speed—Synchro-Silent transmission—New airplane-type shock absorbers, front and rear.

SERIES F-1

Max. Gross Vehicle Weight: 4,700 lbs.
Nominal Tonnage Rating: Half-Ton
6½ FT. STAKE or PLATFORM

THE THRIFTY ANSWER TO LOADS THAT NEED HEADROOM



STEEL INTERLOCKING PLATES bolted to hardwood rack boards hold stake sections firmly but provide easy removal and replacement.

NEW MILLION DOLLAR CAB features new 3-way Air Control, new coach-type seat for comfort, new Level Action cab mounting to frame for longer cab life, new Spiralounge floating seat with jumbo spiral coil spring and hydraulic shock absorber available for comfort-plus.

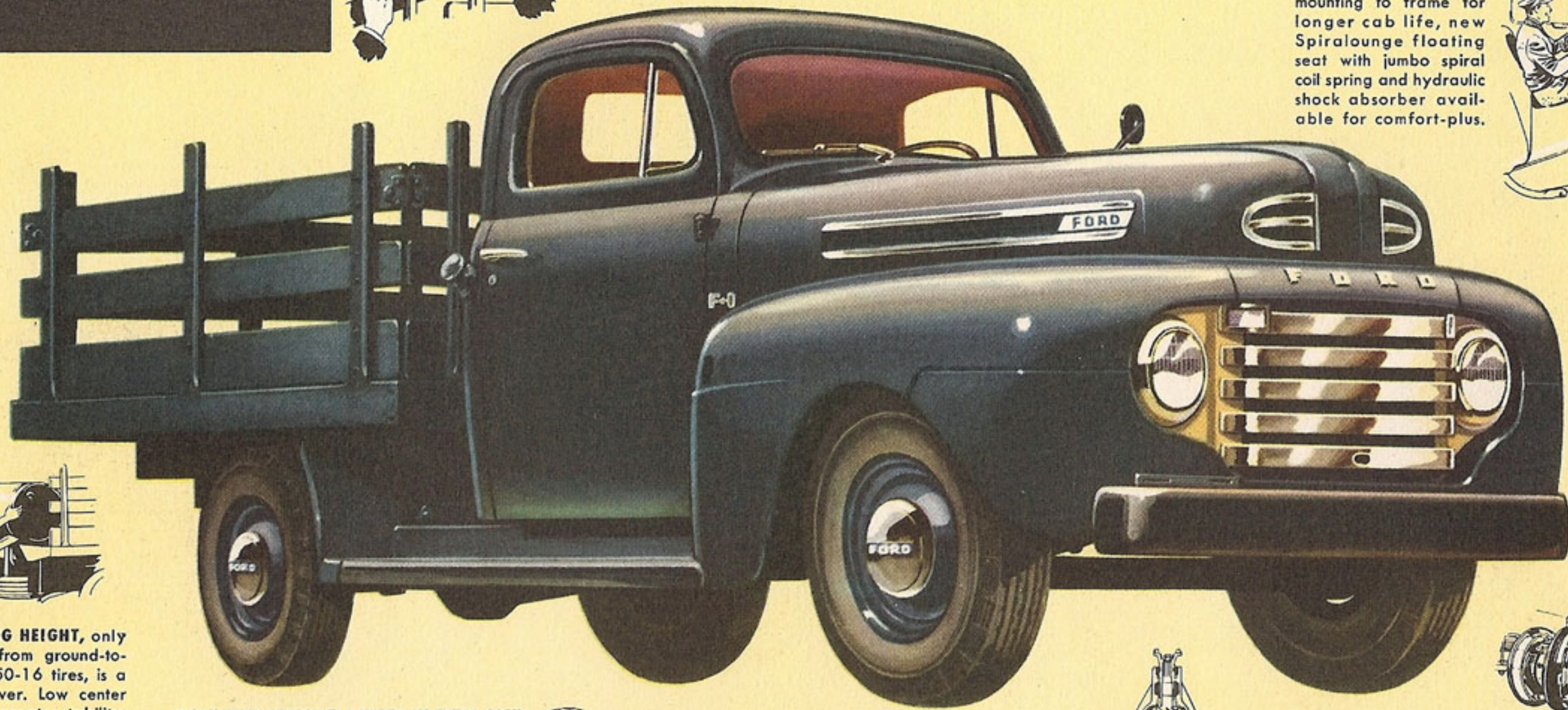

REMOVABLE BRAKE DRUMS simplify maintenance. Drums can be bought separately from hubs for replacement.



LOW LOADING HEIGHT, only 32.6 inches from ground-to-floor with 6.50-16 tires, is a real back-saver. Low center of gravity for greater stability.

RIGHT-HAND WINDSHIELD WIPER AT EXTRA COST.

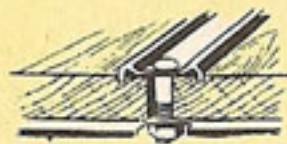

HARDWOOD FLOORS rabbeted and firmly interlocked with long wearing steel skid strips. Floors and stake racks feature select hardwood from Ford's own hardwood forests.

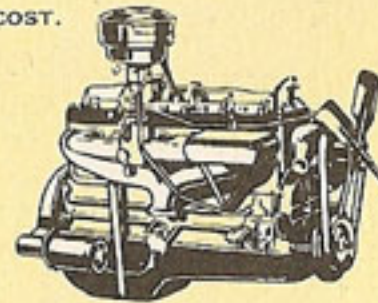

NEW ROUGE 226 TRUCK SIX. A true-truck engine from crankcase up. 95 horsepower. New oil-saver features. New gas-saver features. New advancements throughout. Low r.p.m. at road speeds used most.

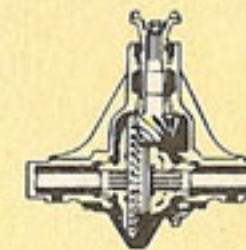

NEW HYPOID REAR AXLE, Semi-floating type. Husky pinion. Quiet running. New, exclusive integral housing fully exposes differential for maintenance. Shafts removable from wheel end.

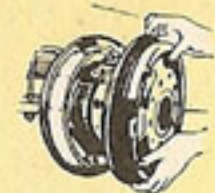

The sky's the load-limit insofar as bulk is concerned for the 6½ ft. Series F-1 Stake. This thrifty load carrier becomes a Platform job with stake sections removed. Curb weight for the Stake is 3,350 lbs. which leaves about 1,350 lbs. for payload before the maximum rated gross of 4,700 lbs. is attained. The Series F-1 Stake handles this gross with ease. With 6.50-16 tires and 3.73 to 1 axle, it pulls a 10% smooth concrete grade in high, better than 30% grade in first. For approximately 14% more pulling ability, a 4.27 to 1 rear axle ratio is available.

ENGINEERING HIGHLIGHTS—NEW F-1 STAKE OR PLATFORM

NEW ROUGE 226 TRUCK SIX—New, longer 4-ring Flightlight pistons save oil—Replaceable-type main and connecting rod bearings—Series-flow cooling with thermostatic control—Alloy exhaust valve seat inserts for longer wear—Improved intake manifold for higher efficiency—New Loadomatic spark control for more power, more economy. New Rouge 239 Truck V-8 available. **CHASSIS**—New Feather-Foot brakes for easy stopping—removable brake drums facilitate servicing—Needle-bearing steering eases control—Flat tube and fin radiator for greater durability—Gyro-Grip clutch multiplies grip with increased speed—Synchro-Silent transmission—Airplane-type shock absorbers.

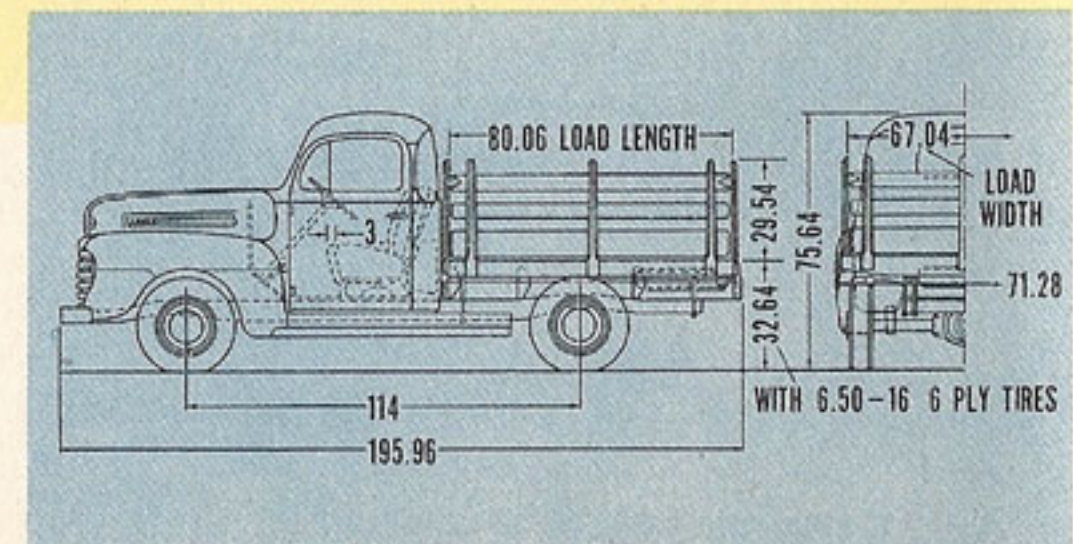

ALL THE BIG TRUCK FEATURES

you've always wanted in a half-ton truck

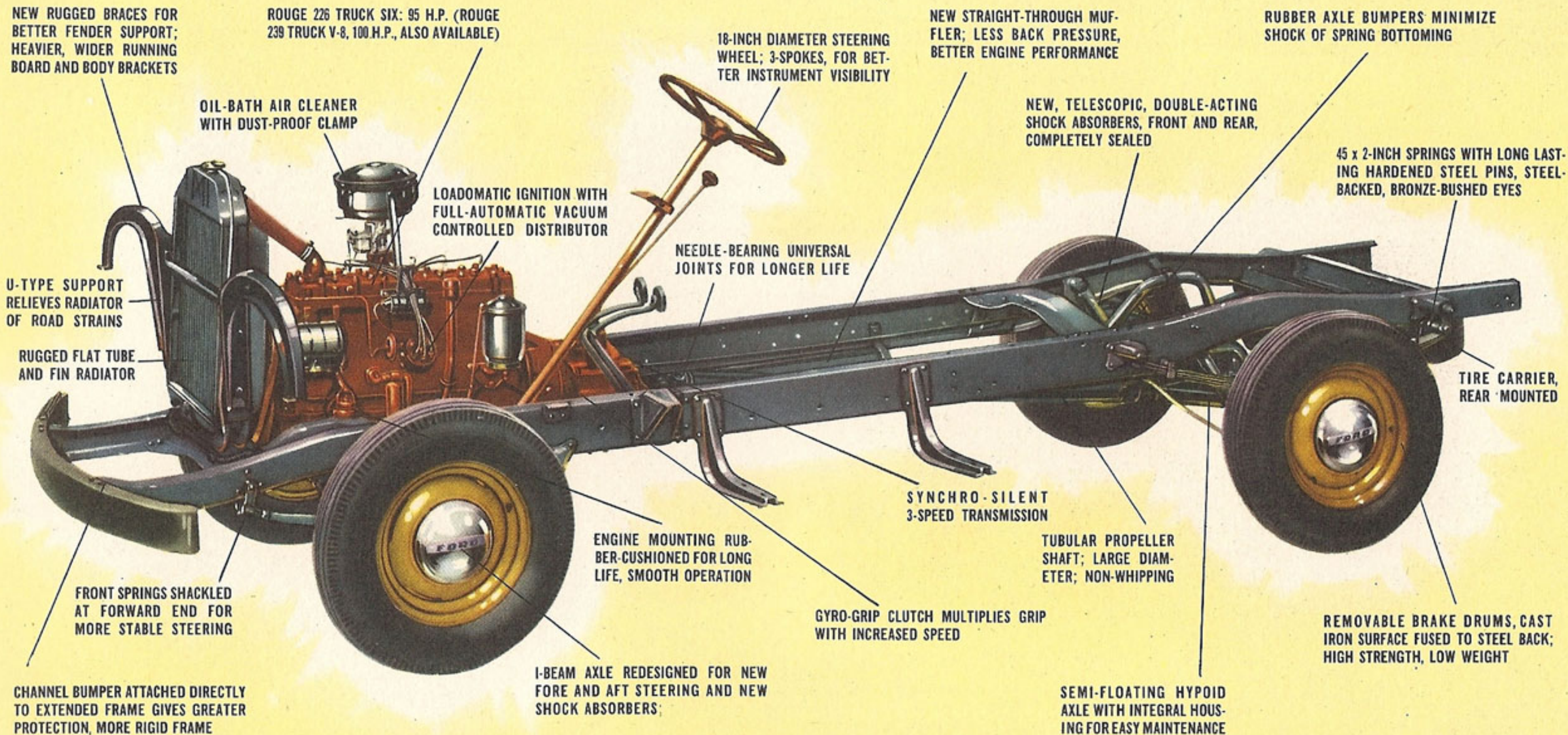

THE NEW SERIES F-1 TRUCK CHASSIS—114-INCH WHEELBASE—4,700 LBS. G. V. W.

CONDENSED SPECIFICATIONS:

ENGINE. 95 H.P. Six or 100 H.P. V-8

CLUTCH. Semi-centrifugal type. Diameter 10 in. Total frictional area 85.5 sq. in. Heavy duty 11-inch clutch optional at extra cost (with four speed transmission).

TRANSMISSION. Three forward speeds. Roller and ball bearings in all forward speeds. Concentric spring-loaded plate type synchronizers. All helical, silent-type gears. Countershaft thrust washers. Four-speed transmission optional at extra cost.

DRIVE LINE. Hotchkiss. Straight-line drive. Highly efficient, long wearing needle bearing universal joints at each end of 3.5 in. diam. tubular propeller shaft.

FRAME. Truck-type pressed steel channel, extended at front for attachment of channel bumper. Frame 34 in. uniform width back of transmission. Side members: depth 5.92 in., width 2.25 in., thickness 0.15 in.

FRONT AXLE. Heat-treated alloy steel forging. Tapered roller wheel bearings; roller or ball thrust bearings.

REAR AXLE. Semi-floating, hypoid gear drive in integral type housing. Differential pinion and side gears backed up with lubricized steel thrust washers. Axle shafts removable at wheel end. Gear ratios: st'd. 3.73 to 1-opt. 4.27 to 1.

SPRINGS. Semi-elliptic. Special alloy steel. Front: length 36 in., width 1.75 in., forward end shackled. Rear: length 45 in., width 2.00 in. Hardened steel pins and steel-backed bronze bushings.

SHOCK ABSORBERS. Four direct, double-acting, telescopic design, with rubber insulated attachments.

STEERING. Heavy duty fore and aft truck type. Short, solid type drag link. Automatic type tie rod ends. Worm and needle bearing roller gear. Ratio 18.2 to 1. Wheel 3-spoke, 18 in. diam.

BRAKES. Hydraulic. Self energizing, two-shoe type. Front 11 in. x 2 in., rear 11 in. x 1 3/4 in. Lining area 178.5 sq. in. Brake drums demountable from hubs, with cast iron braking surfaces fused to pressed steel drum rings. Hand brake lever operates rear wheel brakes by cable control with equalizer.

WHEELS. Five 16 x 4 1/2 K. Steel disc with wide, drop center rims. 5° tapered bead seat.

TIRES. Five. Size: st'd. 6.00-16 4-ply; opt. for max. G.V.W. 6.50-16 6-ply

TREAD. Front 58.08 inches. Rear 60 inches.

TURNING RADIUS. 21 ft. (right); 22.5 ft. (left).

TYPICAL EQUIPMENT. Includes front fenders and running boards on all F-1 chassis with cab; rear fenders included on pickup; hub caps; double-acting shock absorbers, front and rear; cowl ventilator; 20 gallon fuel tank in cab, 17-gallon in-frame fuel tank with chassis with cowl or windshield and panel; spare wheel carrier at rear; spare wheel and spare tire; channel front bumper; channel rear bumper on panel; jack and tool kit. R.H. windshield wiper at extra cost.

FINISH. Frame and bumper black. Black running boards and black wheels except on panel trucks, which are same as body color. Grille and recess Tucson Tan. Fenders, hood, cab and bodies in choice of eight Ford color options

THE NEW ROUGE 226 TRUCK SIX

Designed for truck service
Built for truck service

featuring HIGH TURBULENCE

New Engineering Design Boosts Top Truck Performance, Reduces Truck Operating Costs!

From the mighty Ford Rouge plant, producer of more truck engines than any other plant in history, comes a brand new truck engine, the Rouge 226 Truck Six. Truck-designed and truck-built; the Rouge 226 is truck-proved by over 3,000,000 road-miles of actual operation. Study the horsepower and torque chart (below) for proof of truck-worthiness. It indicates ample power for truck service, and maximum torque developed at moderate speed. Look at the close-ups of true-truck engine features. They emphasize the inherent durability, reliability, ease of maintenance, and the economy of operation built into Ford Truck engines. Among the praiseworthy features not pictured in small illustrations are: simplified generator mounting and belt adjustment; new metal clad ignition coil adjacent to the distributor for higher voltage and easier starting; pressure-valve radiator cap; oil-bath air cleaner with new dust-proof clamp; high capacity packless-type water pump.

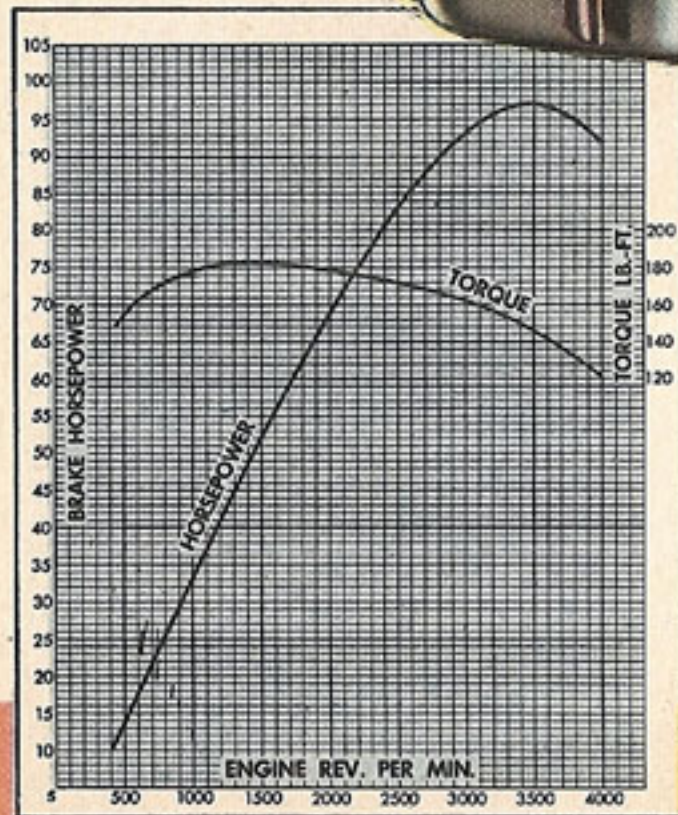
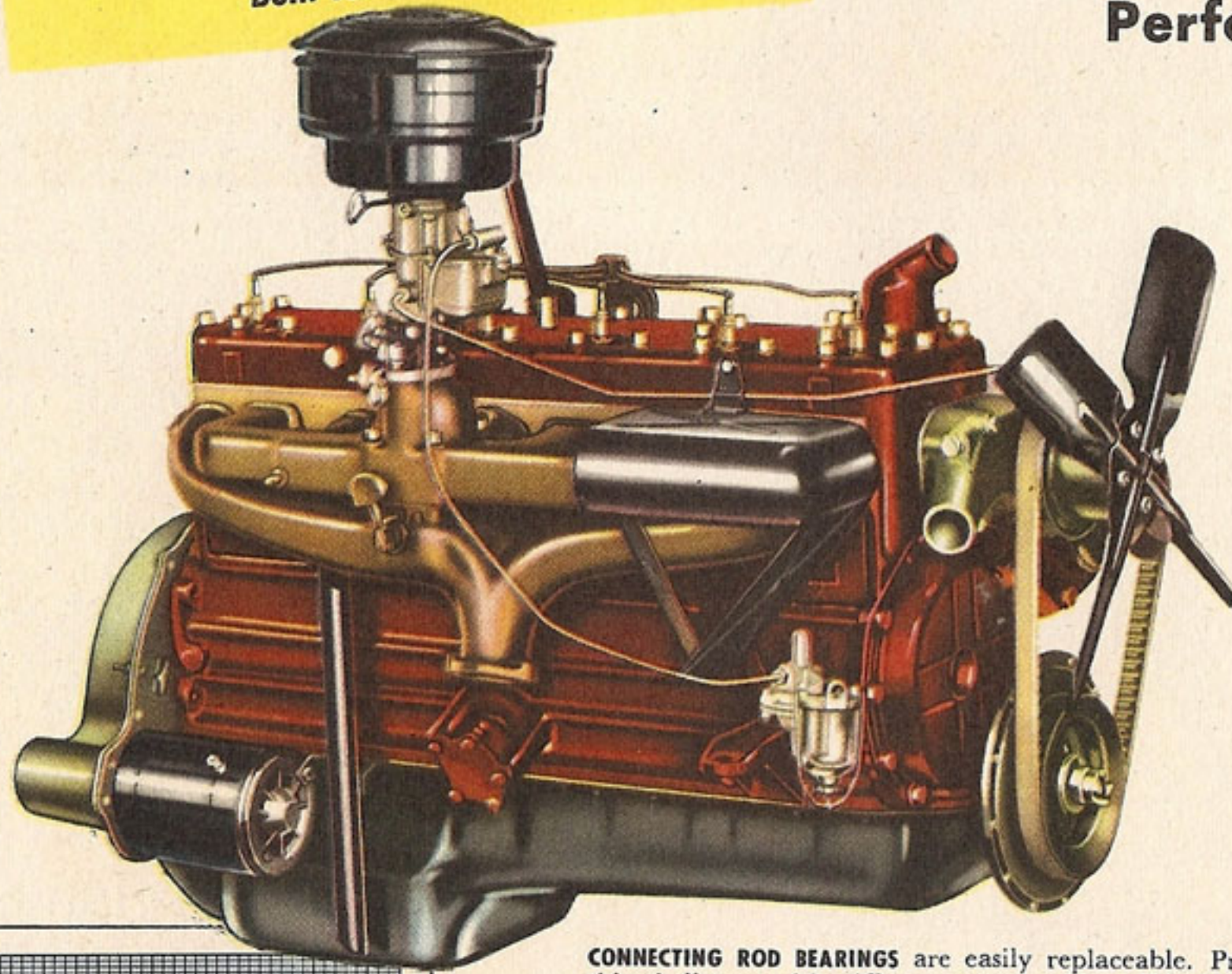

CONNECTING ROD BEARINGS are easily replaceable. Precision thin shell type with stiffer cap, retained by self-locking nuts. Harder, steel-backed, copper-lead alloy for long wear. Pressure lubricated. ▼

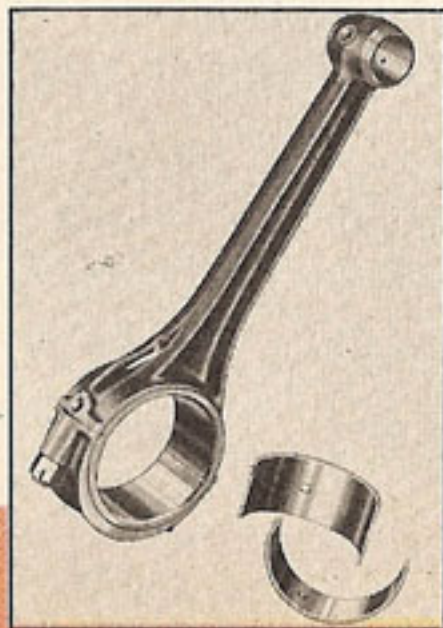

LONGER FLIGHTLIGHT PISTONS for greater gas and oil economy. Aluminum alloy for light weight; cam-ground for true fit at operating temperatures; plated finish for long wear; 4 rings, 2 for compression, 2 for oil control. ▶

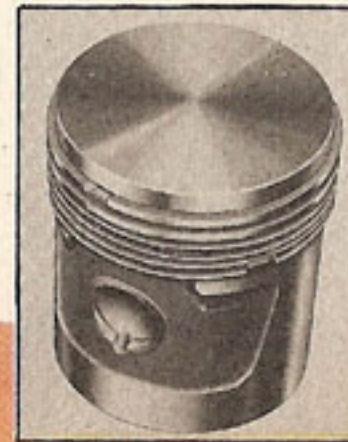

▲ **HEAVIER CRANKSHAFT**, cast alloy steel with 7 counterweights for better balance. Crankpins are tubular for strength with minimum weight. New damper neutralizes torsional vibration.

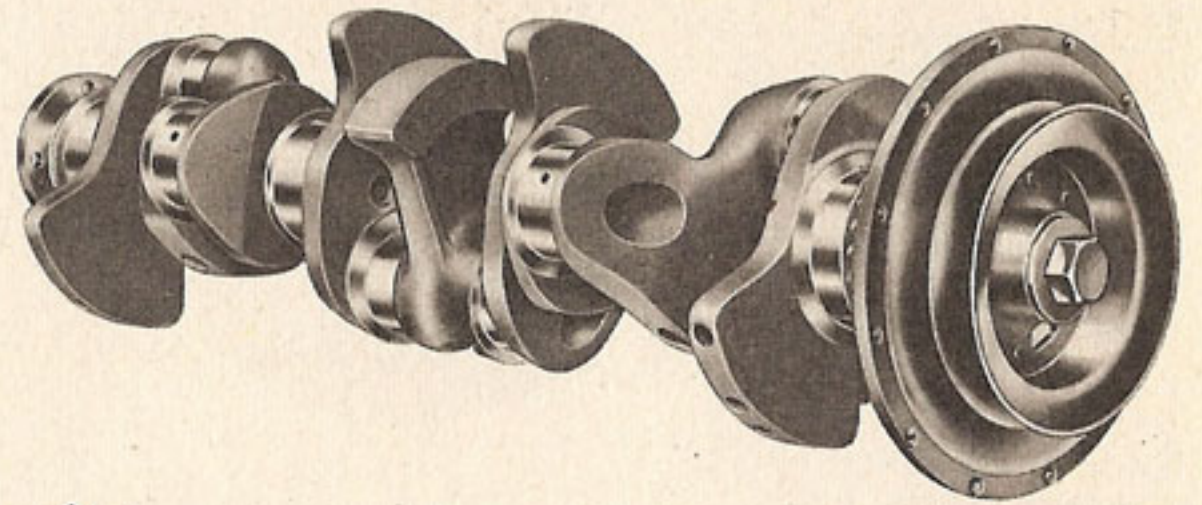

▶ **EXHAUST VALVE SEAT INSERTS** are long-lived molybdenum chrome alloy steel. Need fewer regrinds. Reduce power loss.

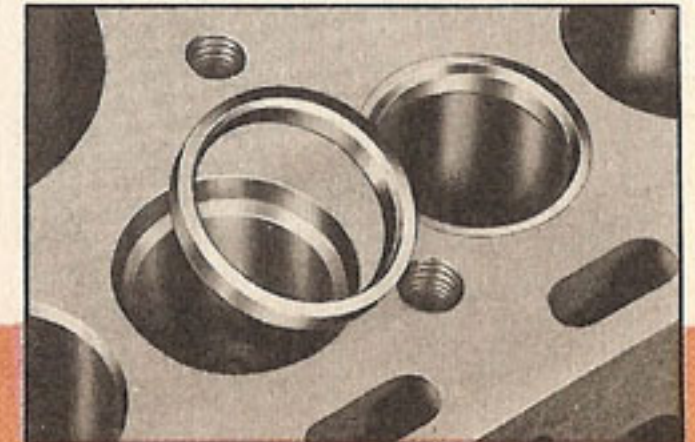

COMBUSTION CHAMBERS the key to new, gas-saving, Ford truck power!

ORDINARY DESIGN

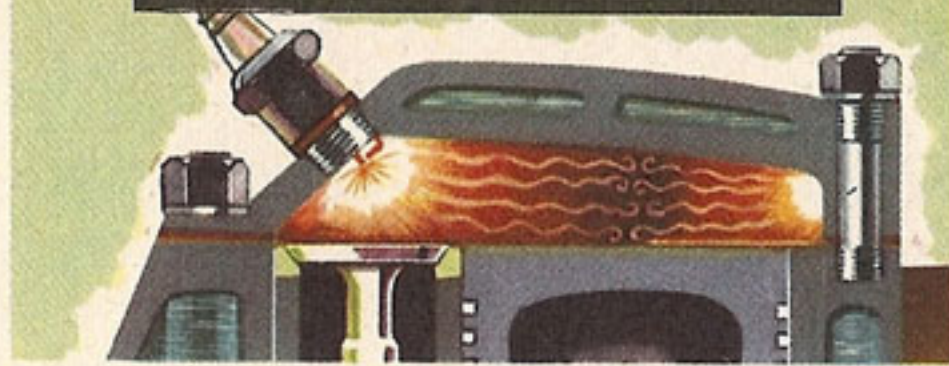

2-Way Gas Waste In Ordinary Combustion Chambers

SPARK KNOCK is one gas-waster by forcing inefficient operation with retarded spark timing. Poor circulation of gas mixture is another. Spark-knock occurs when the gas mixture in the spark-knock pocket pre-ignites independently and in opposition to the main detonation.

HIGH TURBULENCE DESIGN



Ford Reduces Spark Knock To Save Gas

HIGH TURBULENCE combustion chamber design saves gas by minimizing spark-knock. Chamber contour is designed to concentrate fuel around spark plug, narrow the spark-knock pocket. The piston gets a desirable prolonged "push", not an undesirable quick hammer blow.



Ford Speeds Circulation To Save Gas

HIGH TURBULENCE combustion chamber design saves gas by speeding circulation of the gas mixture. Chamber design imparts a "tempest-whirl" to incoming gas mixture and outgoing exhaust gases. Full fuel charges rush in, exhaust sweeps out for top-notch combustion.

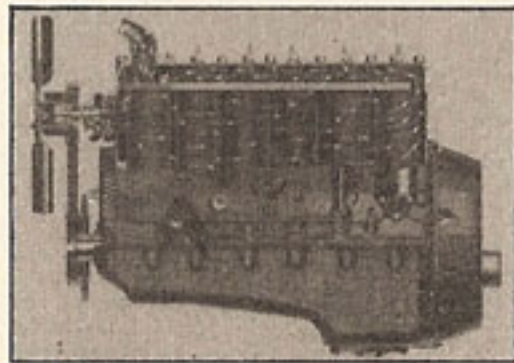

NEW SERIES-FLOW WATER COOLING is more efficient, offers better temperature control, prevents "hot spots"

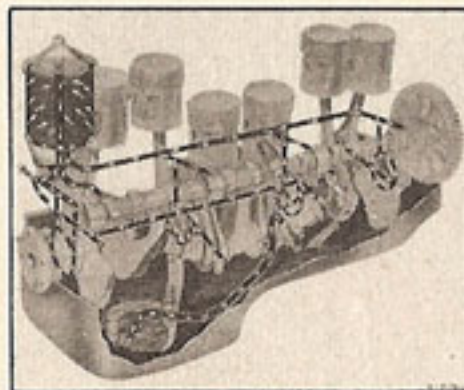

FULL PRESSURE LUBRICATION of all main bearings, connecting rod bearings and camshaft bearings for long life.

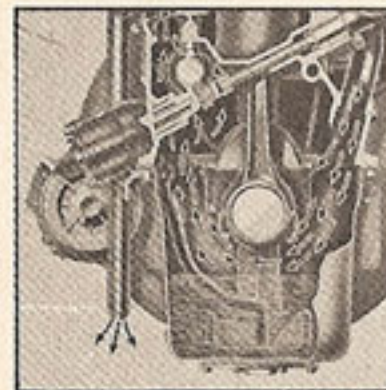

NEW ROTOR-TYPE OIL PUMP with 172% greater capacity. Greater pressure. Accessibly located.

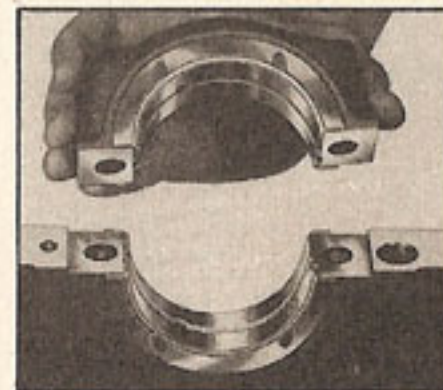

REPLACEABLE MAIN BEARINGS, long wearing, steel-backed copper-lead alloy.

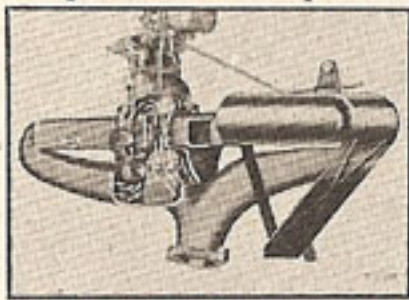

ADJUSTABLE-TYPE VALVES feature self-locking screw-type tappets.

NEW INTAKE MANIFOLD traps raw gas, has less restriction in riser, reduces condensation, improves starting.

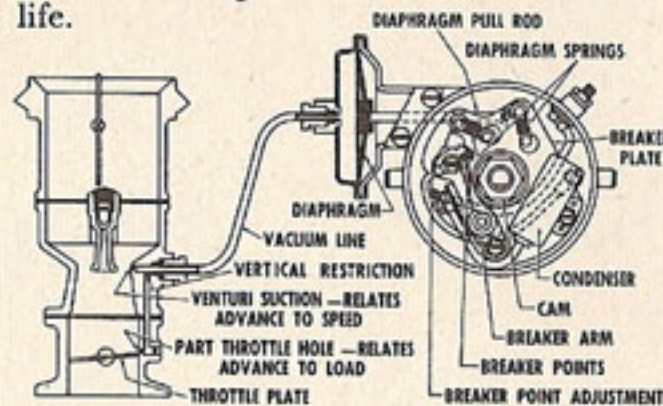

NEW VACUUM-CONTROLLED DISTRIBUTOR with full-automatic spark advance regulated by carburetor air velocity and manifold vacuum.

BASE-MOUNTED OIL FILTER with no external oil lines. Renewable cartridge type. Relief valve by-passes filter if cartridge becomes blocked.

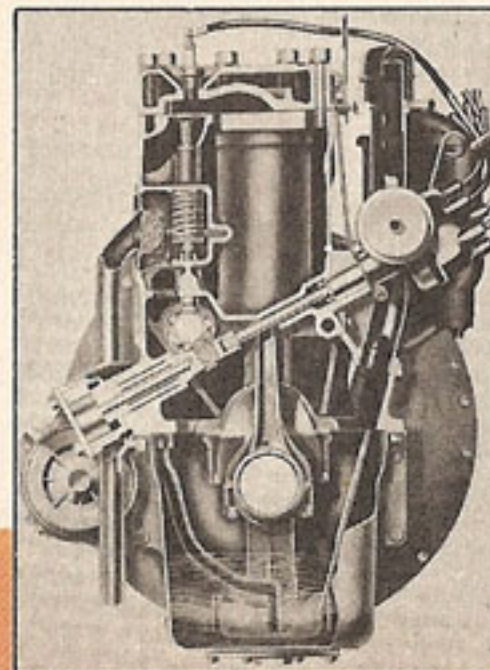

SUCTION-TYPE CRANKCASE VENTILATION reduces crankcase dilution and sludge formation, prolongs engine life.

NEW ROUGE 239 TRUCK V-8

Available at extra cost

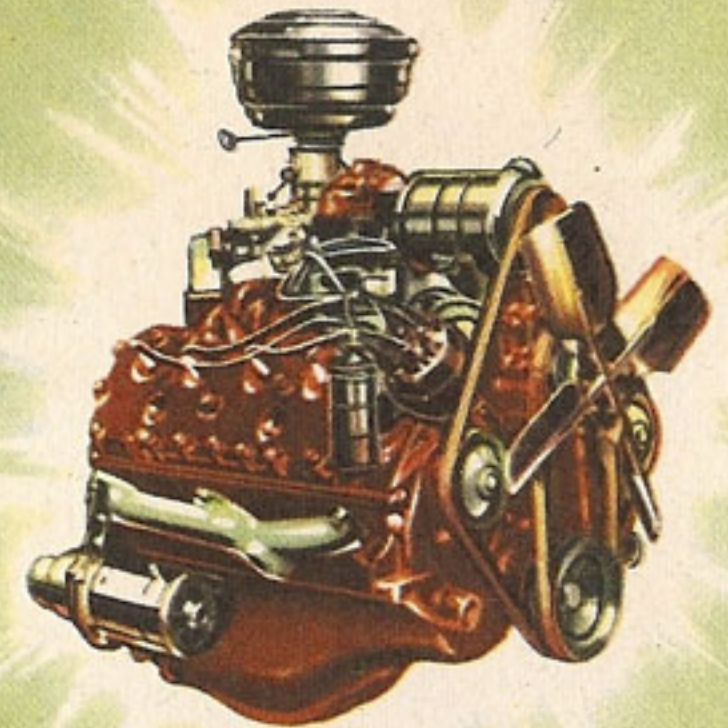

100 Horsepower. 180 lb. ft. torque at 2,000 r.p.m. Bore 3.187 inches. Stroke 3.75 inches. Cast alloy iron block. High turbulence, high compression combustion chambers. Flight-light pistons. 4-rings. Removable-type main and connecting rod bearings. Intake and exhaust valve seat inserts. Downdraft carburetor. Loadomatic ignition with vacuum controlled distributor.

THE "BIG INCH" PIPELINE OF FORD TRUCK POWER

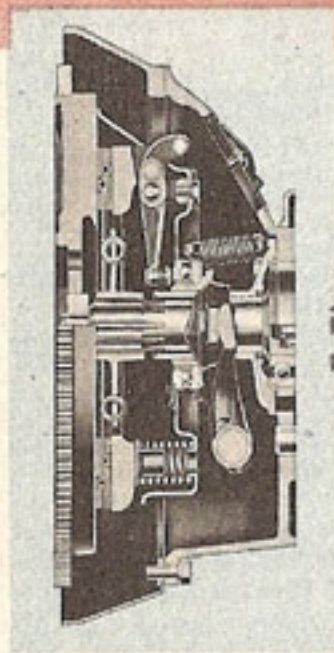

GYRO-GRIP CLUTCH multiplies grip as speed increases. Ample capacity to handle full engine torque. Cushion disc construction prevents grabbing.

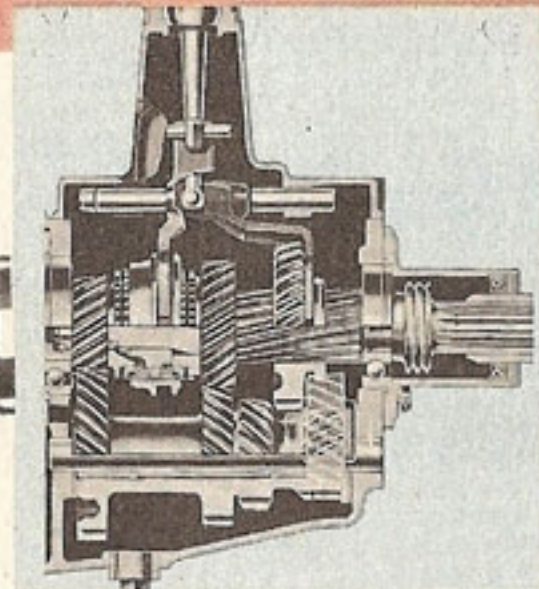

NEW 3-SPEED SYNCHRO-SILENT TRANSMISSION offers quiet, easy shifting. All gears are wide contact Bonus Built helical type. Thrust washers take countershaft thrust and wear. Series F-1 illustrated, other models have 4-speed type.

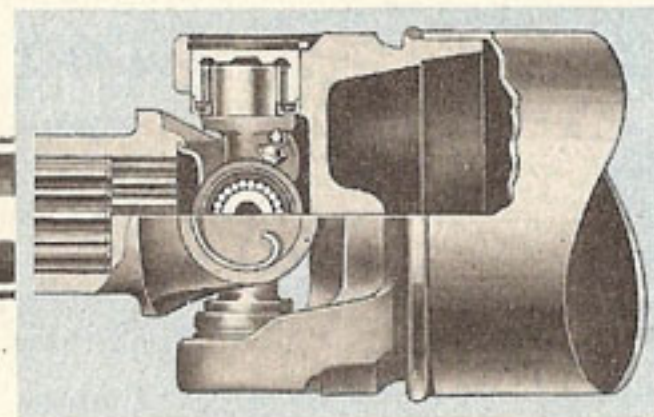

TRUCK-TYPE UNIVERSAL JOINTS of needle bearing design deliver full torque with minimum friction. Lubrication and relief fittings are designed to prevent damage to sealing washers while greasing.

PROPELLER SHAFT is large diameter, non-whipping, tubular type. Torque capacity is many times that required in full-load high gear work, well beyond that required for low gear truck work.

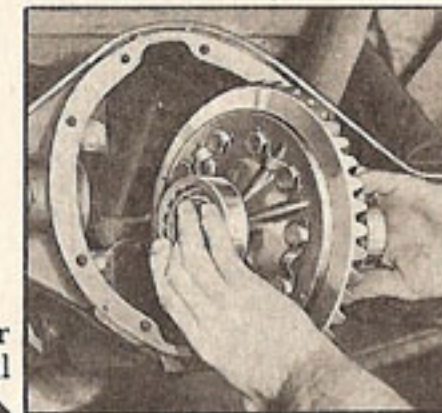

INTEGRAL HOUSING with large removable cover plate (F-1) permits easy removal of differential assembly and drive pinion for maintenance.

STRONG POINTS OF THE '48 FORD TRUCK CHASSIS

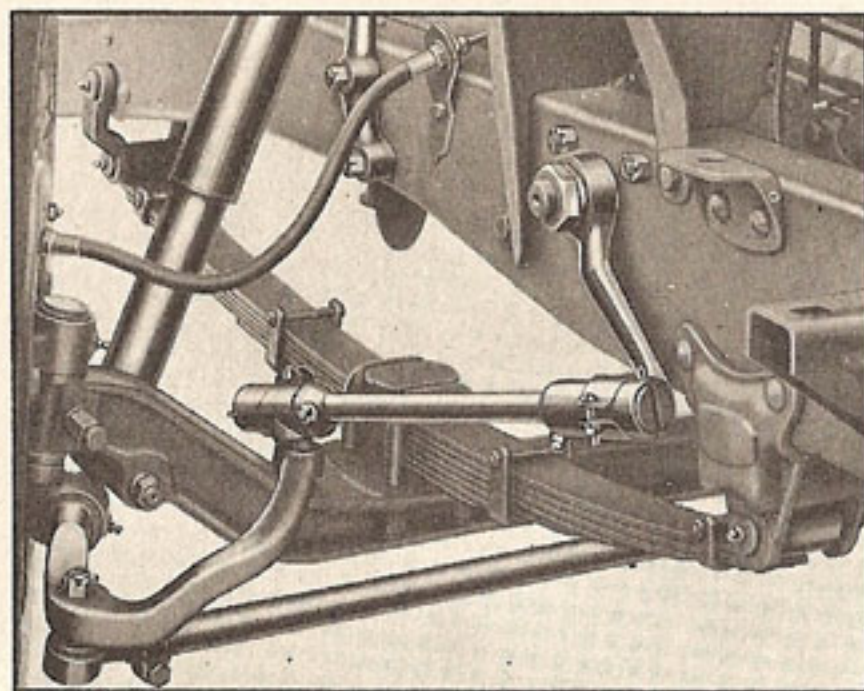

NEW STEERING LINKAGE provides more uniform, more stable steering control. Heavy duty fore and aft type. Short, direct-acting, solid type drag link. New U-type steering arm. Springs are shackled at the forward end.

TIE ROD ENDS are spring loaded ball-socket type providing automatic take-up of wear. Rubber dust shields keep out grit, prolong life.

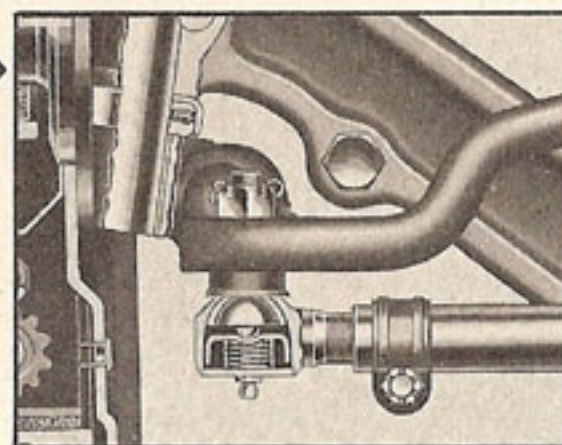

CHANNEL BUMPER is attached directly to extended frame for greater protection; acts as an additional cross member for extra frame reinforcement.

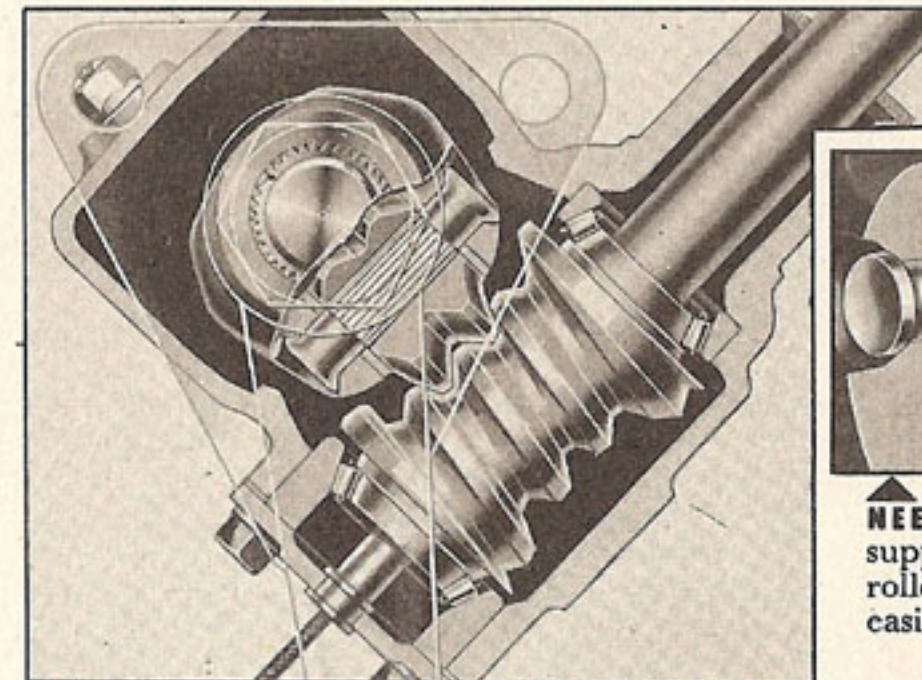
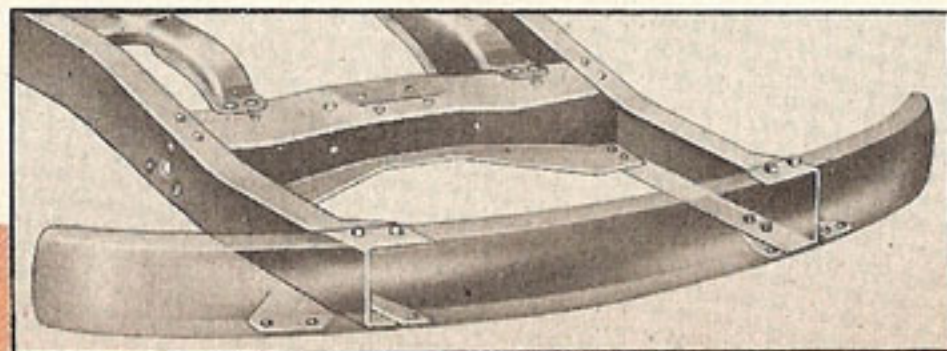

ROLL-ACTION STEERING GEAR takes friction out of truck steering at three key points. The roller is designed to "roll" rather than slide over the worm threads; two opposed tapered roller bearings support the steering worm; needle bearings support the steering roller. Roller shaft and worm are adjustable.

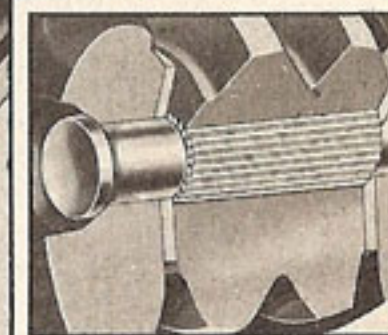

NEEDLE BEARINGS support the steering roller, make steering easier, reduce wear.

...Bonus Built with Big Reserves for Tough Going

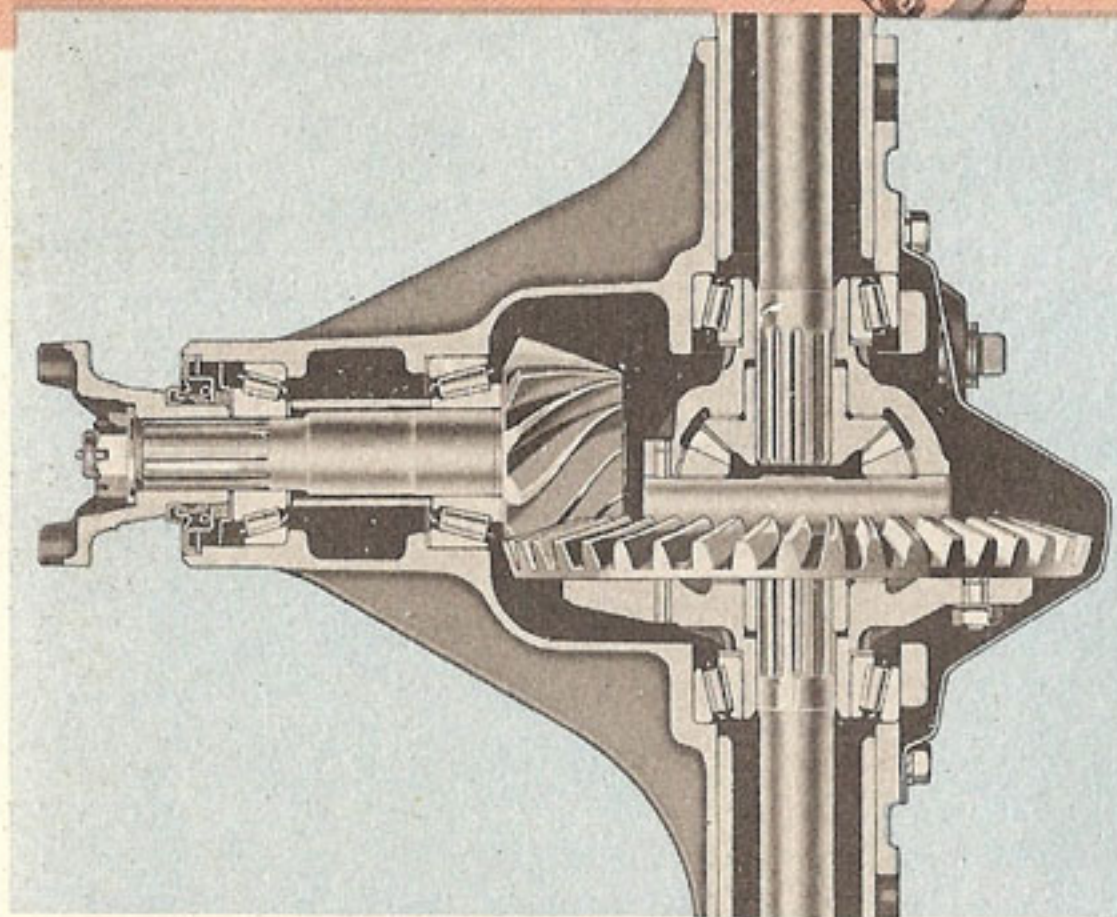

◀ **SERIES F-1 HYPOID REAR AXLE**, semi-floating design, features integral type housing. Differential assembly and drive pinion are installed through the full-size opening at the rear of the axle housing. Inspections and adjustments may be made without removing the housing, or disturbing the brake line connections. The husky hypoid drive pinion is held firmly by two tapered roller bearings. Differential pinion and side gears are backed up with lubricized steel thrust washers. Large diameter axle shafts float in pre-lubricated and sealed ball bearings. Shafts can be removed from the wheel end without disturbing the housing.

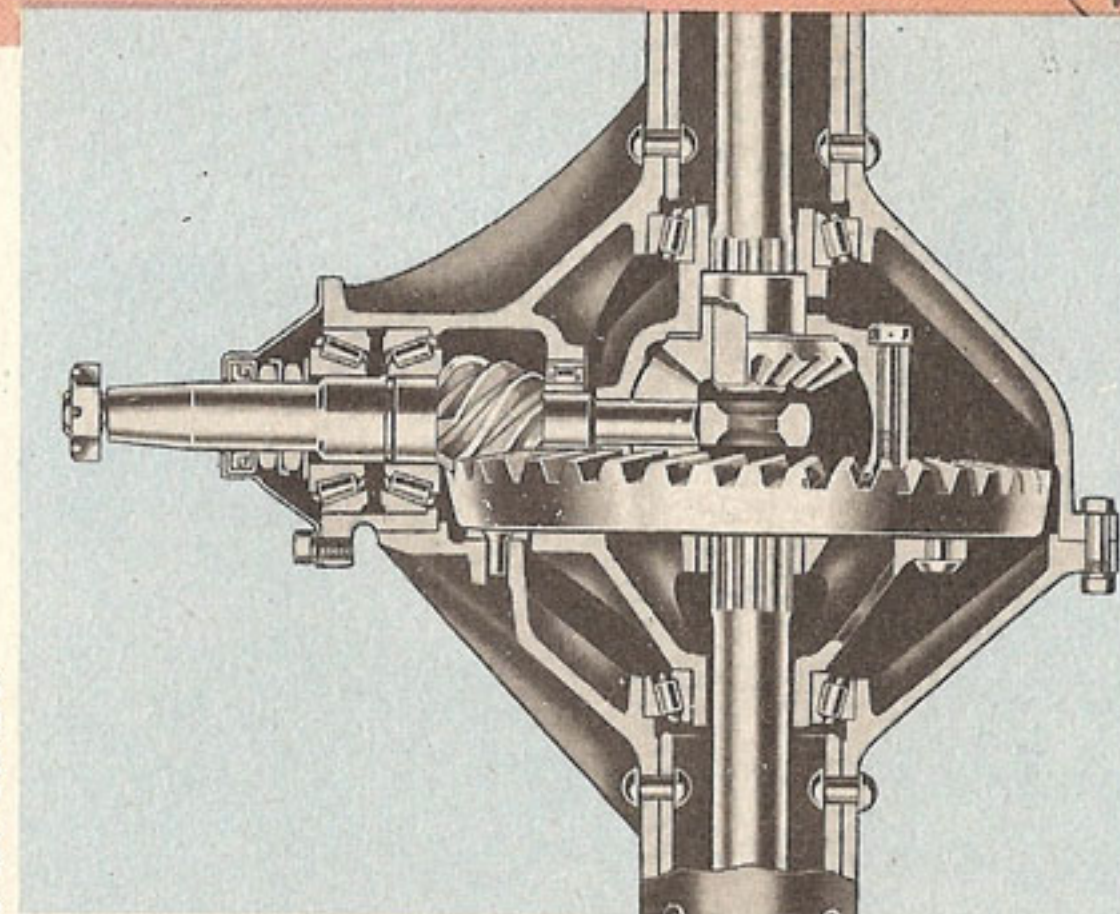

▶ **FULL FLOATING REAR AXLE** for models F-2, F-3 and F-4. Pinion is straddled by two tapered roller bearings in front, straight roller bearing in rear. Front pinion bearing is positively lubricated with oil carried up by ring gear. Four differential pinions spread power load evenly, with low tooth stresses. (F-2 shown).



◀ **CAST IRON BRAKE DRUM** minimizes scoring and warping; is fused to a steel back; adds strength, saves weight. (F-1 shown).

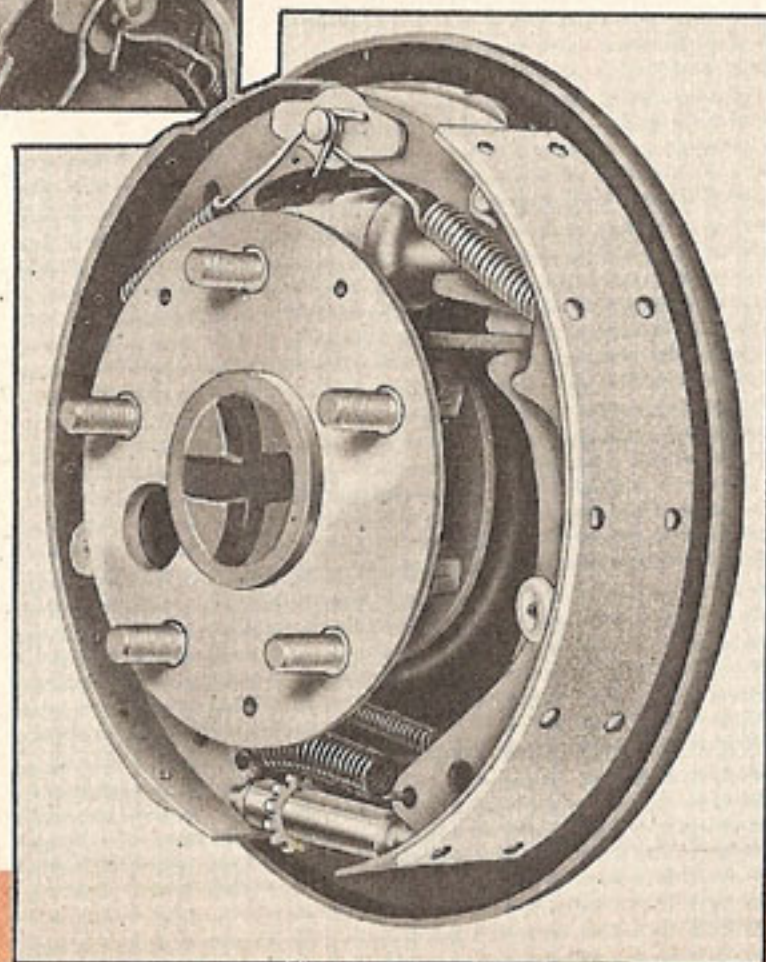

◀ **NEW FEATHER-FOOT HYDRAULIC BRAKES** feature big lining area and Bonus-Built construction for long brake life in tough truck service. Self-energizing action (in F-1 brakes shown) builds up brake shoe pressure within the brake itself, eases foot pedal pressure requirements. Brakes are easily adjusted.

▶ **REMOVABLE BRAKE DRUMS** simplify maintenance. Drums can be bought separately from hubs for replacement.



▶ **NEW, AIRPLANE-TYPE SHOCK ABSORBERS**, direct, double-acting, completely sealed. Standard, front and rear F-1 and F-2; front only on F-3.



▶ **REAR SPRINGS** (F-1 shown) are Bonus-Built to handle full capacity loads; offer safe, soft handling of fragile loads. Spring material has tensile strength of 200,000 lbs. per sq. in. All shackle pins, front and rear, are interchangeable. Spring seats welded to axle housing. Brackets are cold-riveted to frame at cross member locations in Bonus-Built construction.

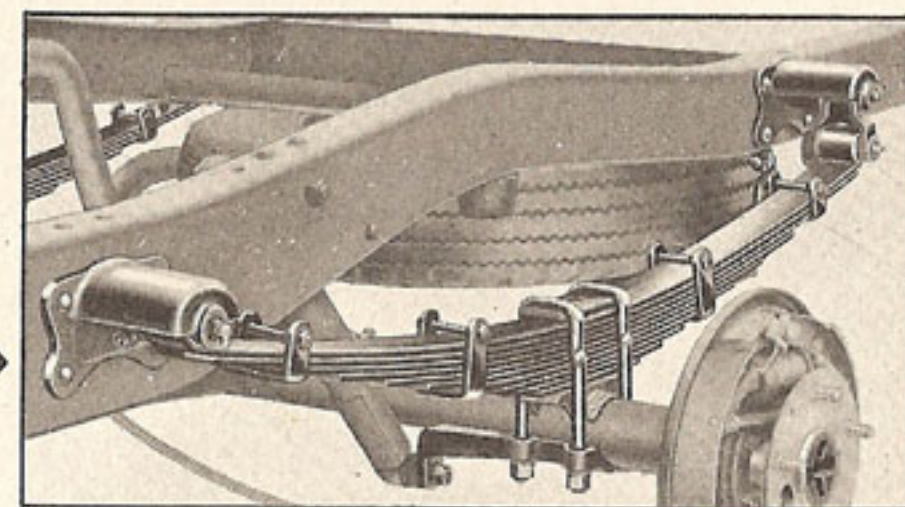

▶ **NEW RUBBER BUMPERS** mounted on frame provide progressive rate change to cushion shock of front springs "bottoming"

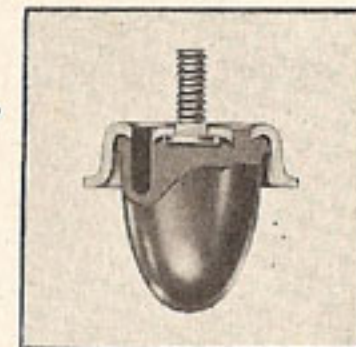

▶ **NEW STRAIGHT THROUGH MUFFLER** cuts down restriction, reduces back pressure, improves engine performance and gasoline economy.

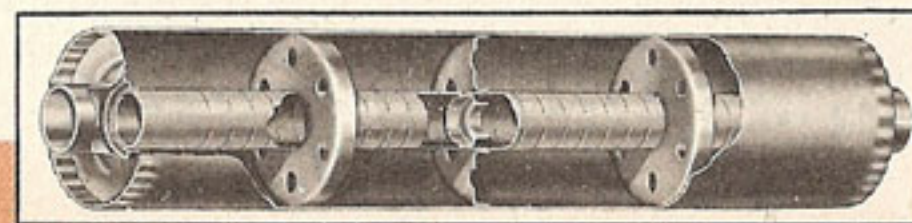

NOW! *Living Room Comfort.*

NEW COMFORT AND ROOMINESS GIVE DRIVERS MORE LEG, HEAD AND ELBOW ROOM!

Ford invested over one million dollars in new production tooling to provide drivers new spacious comfort and roominess. The new Ford MILLION DOLLAR truck cab is bigger in every way. Wider! Longer! Taller!

Drivers of the new Fords are through with squeezing-into and out of restricted doorways. The new Ford cab doors are wider. Footroom between the seat riser and pillar has been increased to permit even "size 13's" to get through without stumbling. There's headroom, too, and plenty of it in the new Ford cab . . . one of the biggest in its class.

There's comfort and neatness in the full interior trim, the handsome upholstery. Other appreciated comforts include a sun-visor, ash tray, easily read instruments and husky hardware. All these features are encased in a weatherproof, all-steel structure designed to perpetuate the proved long-life superiority of Ford Trucks.

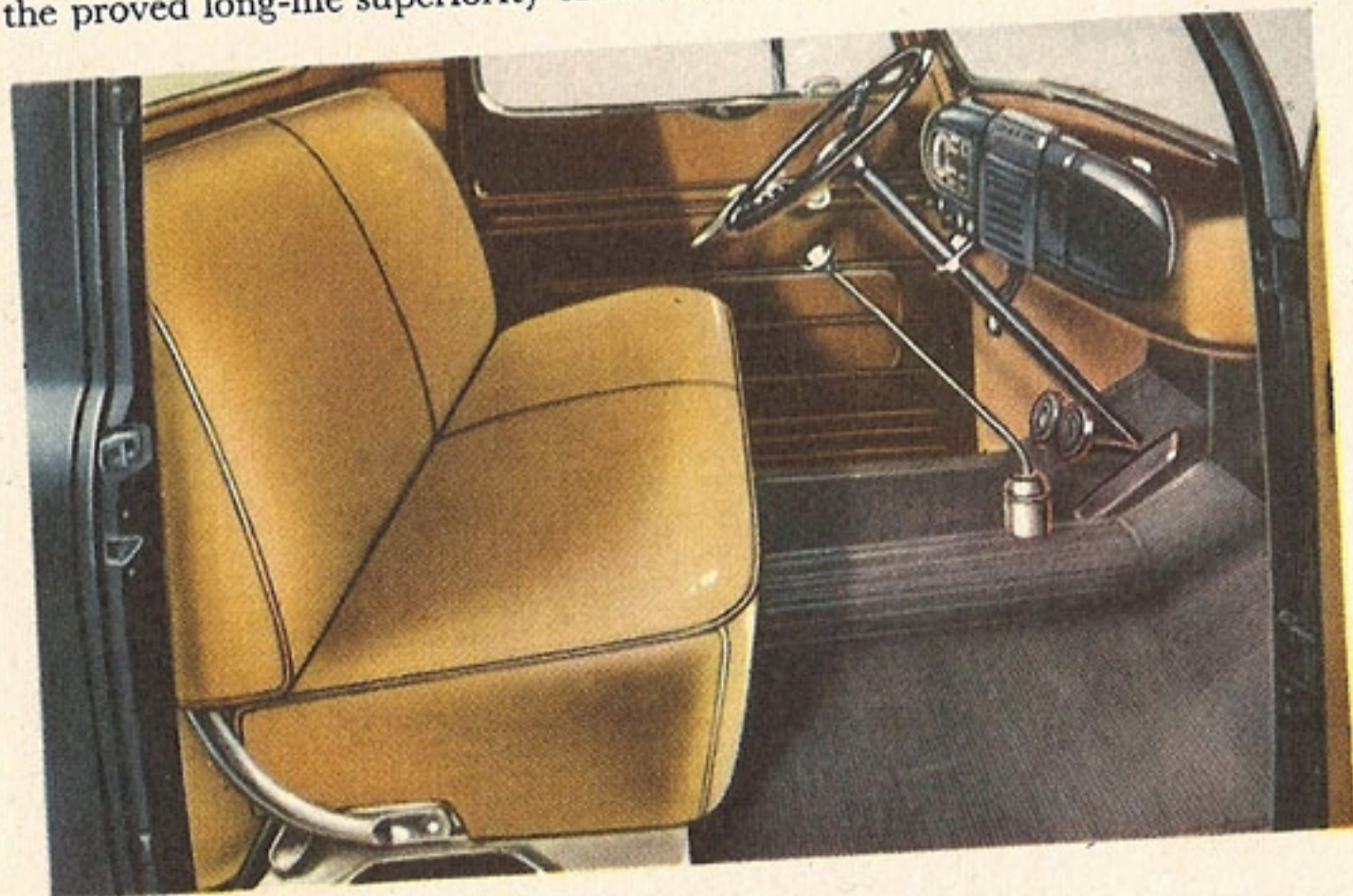

NEW 3-WAY AIR CONTROL SCOOPS IN OCEANS OF FRESH AIR!



1 Air-Wing Ventilators—Scoop in fresh air, sweep out stale air. Easily locked, tight fitting. Standard equipment for maximum comfort in all Ford cabs.

2 Cowl Ventilator—Extra large size. Equipped with anti-bug screen, rubber weather-seal and water drain. Regulator holds ventilator open in any desired position.

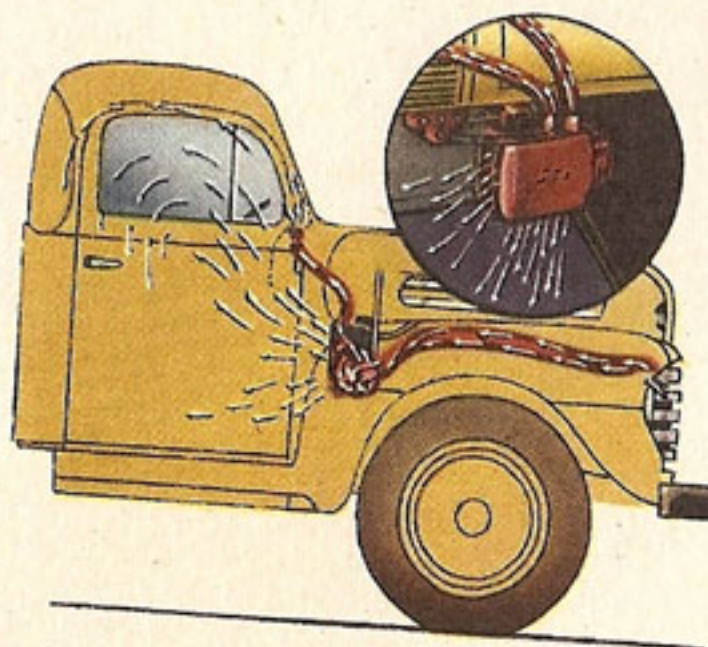
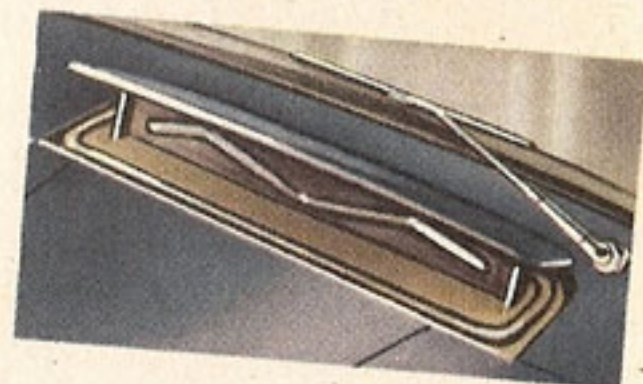

3 Fresh Air Intake Heater and Defroster—For cold weather driving, an efficient ram and blower heater that pressurizes the cab for more uniform heat distribution throughout. In mild weather reduces window fogging and provides twice the usual volume of hot air to defroster vents. At all times, it's an extra source of fresh air. Heating unit is hot water type. Available at slight extra cost.

IN THE NEW FORD *Million Dollar* TRUCK CAB

NEW EASY CHAIR COMFORT CUSHIONS THE MILES!



COACH SEAT

Seat cushion and back assembly adjustable fore and aft 3 in. on rollers, finger-tip control. Seat back inclination independently adjustable. Thick rubberized hair padding, individually pocketed coil springs and scientifically designed cushion contours make the new Bonus Built seat the finest standard truck seat ever built!

Spiralounge seat, floated on a variable-rate spiral coil spring adjustable to driver's weight. Hydraulic shock absorber controls movement of seat and back. Available in models with cab.



SPIRALOUNGE SEAT

NEW LEVEL ACTION CAB SUSPENSION INSULATES CAB FROM FRAME WEAVE

In this new, exclusive, Ford cab suspension, rubber pads and rubber insulated bolts at each front corner and Level Action links in torsion type rubber bushings at each rear corner provide . . . the *stability* which only 4-point suspension can give . . . the *flexibility* needed to ride out the rockiest going . . . the *cushioning* effect of a free linkage action . . . which insulates the cab from vibration, noise, and frame weave, thus materially prolonging cab life.

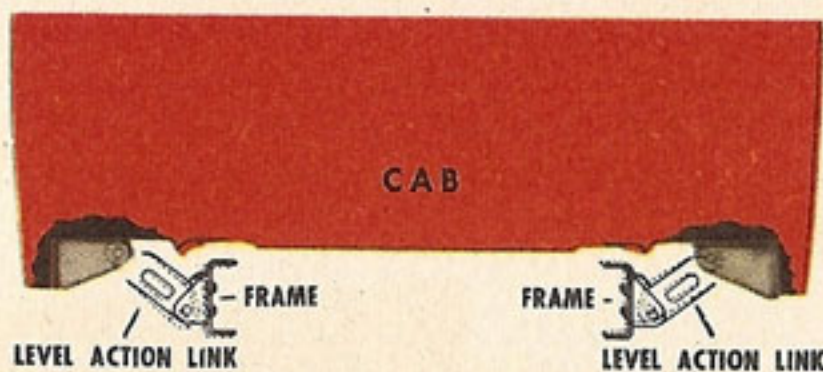

NEW PICTURE WINDOW VISIBILITY MAKES DRIVING SAFER!



One-piece Safety Vision Windshield, plus narrow corner pillars, make for wide-range visibility. Windshield has no center obstruction to vision. Height increased for tall drivers.

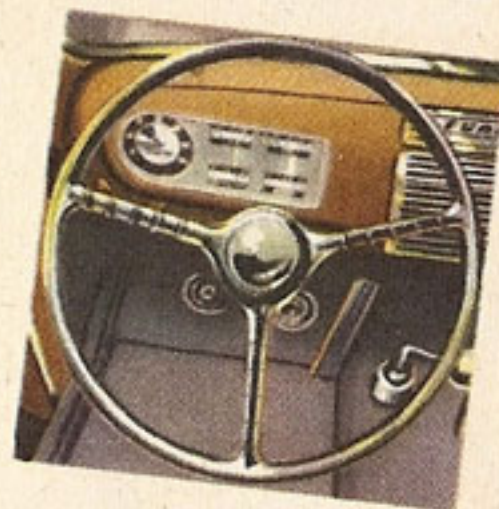

Handsome instrument cluster designed for split-second reading with minimum obstruction by steering wheel spokes. Ash tray accessibly located. Extra big glove compartment.

Extra large rear cab window offers great convenience by improving rear visibility.

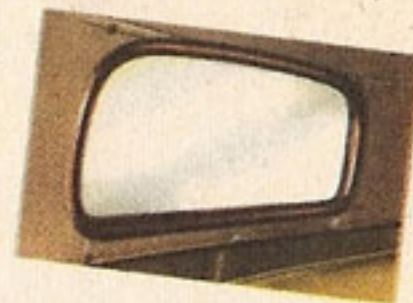

SERIES F-2

Max. Gross Vehicle Weight: 5,700 Lbs.

Nominal Tonnage Rating: 3/4 Ton

8 FT. EXPRESS

7 1/2 FT. PLATFORM STAKE

BIG, BIG, EXTRA BIG BODIES TO WHISK LIGHT BULKY LOADS!

CAPACITY-PLUS is available in the 62.43 cu. ft. Ford Express body. Low floor height, slightly over 25 inches from floor to ground, facilitates loading

NEW MILLION DOLLAR CAB features new 3-Way Air Control. New coach-type seat for comfort. New Level Action cab mounting to frame for longer cab life. New Spiralounge floating seat with jumbo spiral coil spring and hydraulic shock absorber available for comfort-plus.

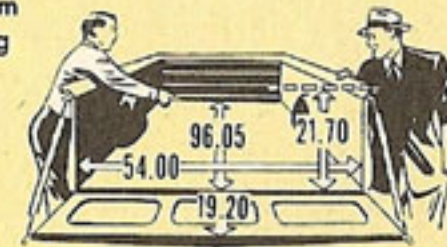

4-SPEED TRANSMISSION offers extra pulling ability in first gear, as much as 100% more than typical 3-speed transmission in some light trucks.

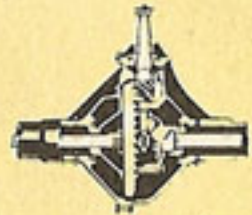
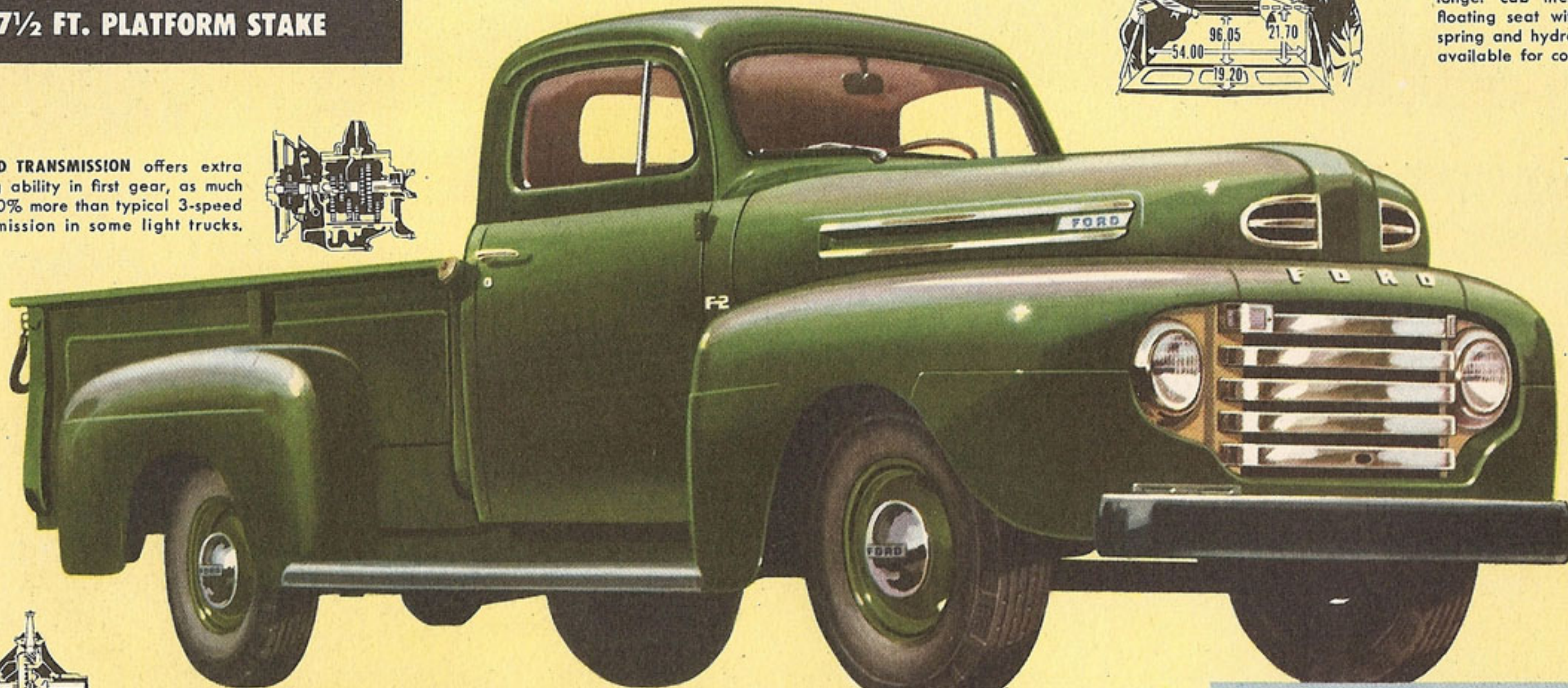
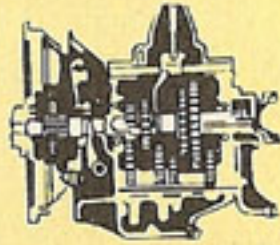

FULL FLOATING REAR AXLE, same type construction used in heaviest trucks. Straddle-mounted pinion. Axle shafts float, carry no load weight, are removable from wheel end.

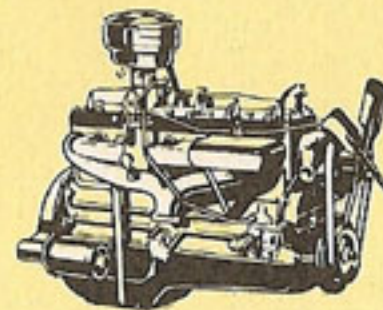

NEW ROUGE 226 TRUCK SIX. A true-truck engine from crankcase up. 95 horsepower. New oil-saving and gas-saving features. New advancements throughout. Low r.p.m. at road speeds used most.

RIGHT-HAND WINDSHIELD WIPER AND HUB CAPS AT EXTRA COST.

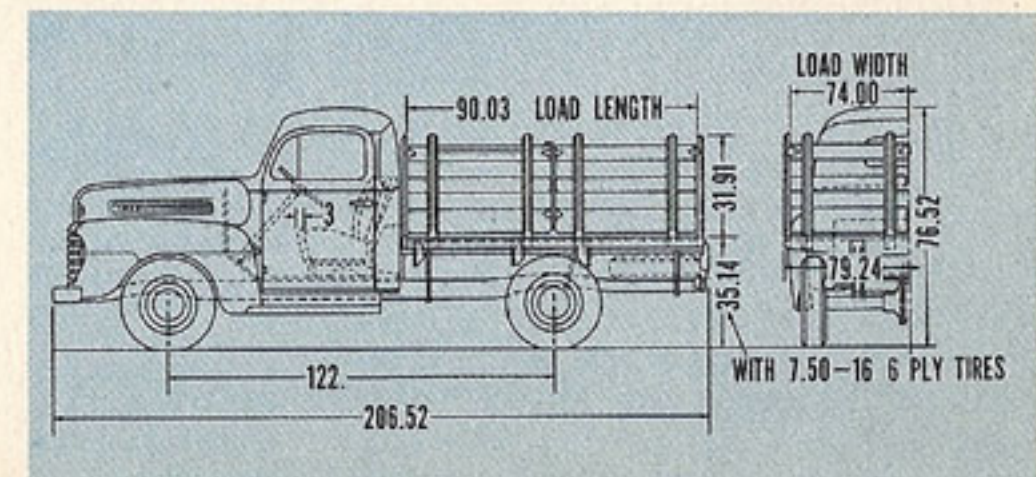
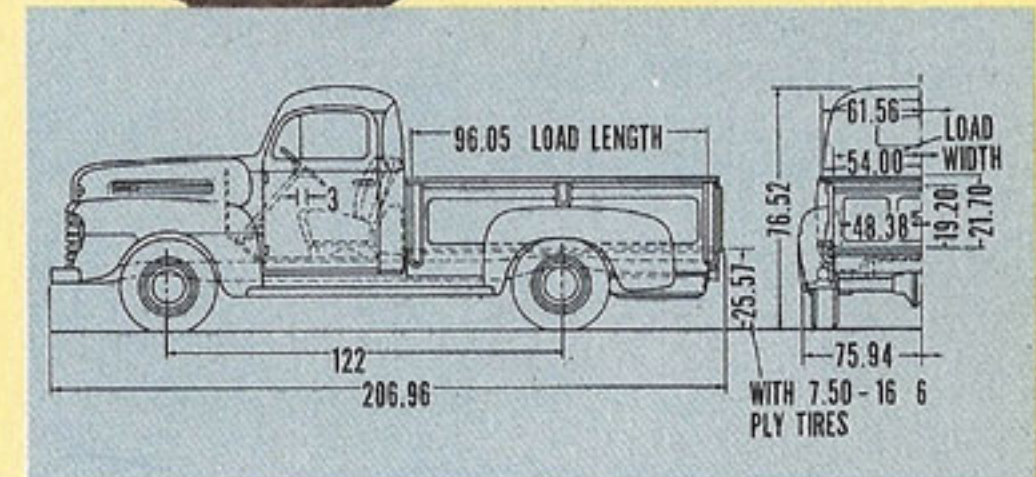

With maximum gross weight of 5,700 lbs. and a curb weight of 3,765 lbs., the F-2 Express offers a payload capacity of about 1,935 lbs. on 7.00-16 6-ply tires. Because of slightly heavier body, payload capacity of the Stake is about 105 lbs. less. Equipped with the standard 4.86 to 1 rear axle ratio, the F-2 handles its gross load with ease. It pulls an 11% smooth concrete grade in high gear . . . better than a 30% grade in first gear. Engine speed at 35 m.p.h. is an economical 1,965 r.p.m.

ENGINEERING HIGHLIGHTS—NEW F-2 EXPRESS OR STAKE

NEW ROUGE 226 TRUCK SIX—New, longer 4-ring Flightlight pistons save oil—Replaceable-type main and connecting rod bearings—Series-flow cooling with thermostatic control—Alloy exhaust valve seat inserts for longer wear—Improved intake manifold for higher efficiency—New Loadomatic spark control for more power, more economy. New Rouge 239 Truck V-8 available. CHASSIS—Feather-Foot brakes, fixed-anchor type, for easy stopping—New fore and aft steering for more uniform response—Needle-bearing steering eases control—Flat tube and fin radiator for greater durability—Gyro-Grip clutch multiplies grip with increased speed—New Airplane-type shock absorbers.

RUGGED ENGINEERING THROUGH AND THROUGH

for extra thrift, extra reliability, extra durability on your job

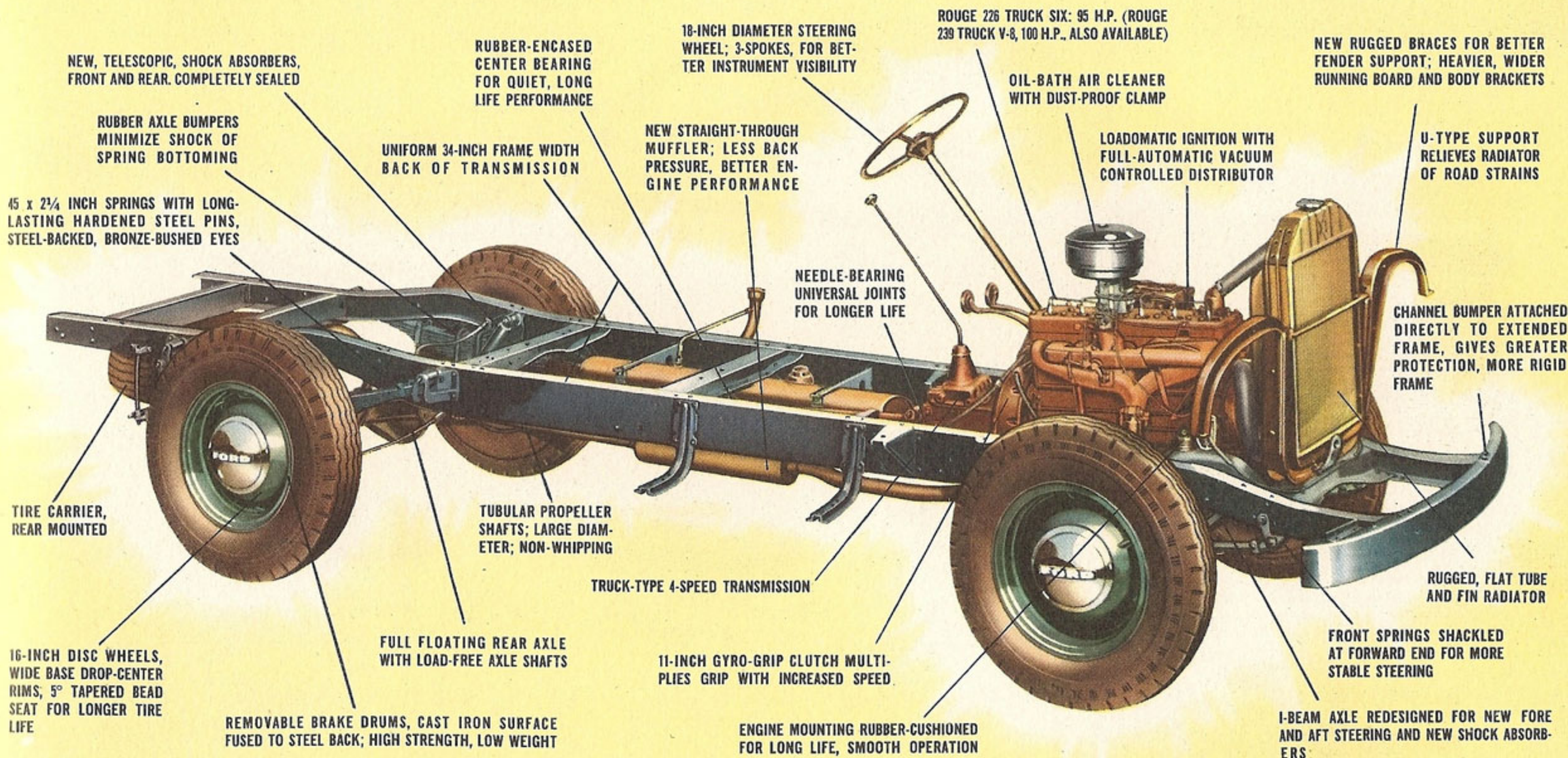

THE NEW SERIES F-2 TRUCK CHASSIS—122-INCH WHEELBASE—5,700 LBS. G. V. W.

CONDENSED SPECIFICATIONS:

ENGINE. 95 H.P. Six or 100 H.P. V-8

CLUTCH. Semi-centrifugal type. Diameter 11 in. Total frictional area 123.7 sq. in.

TRANSMISSION. Heavy duty, 4-speed sliding gear type. Two-piece case design—with separate clutch housing. All gears forged from alloy steel, heat treated. Roller and ball bearings in all forward speeds. Spring-loaded internal reverse lock. Countershaft thrust washers.

DRIVE LINE. Hotchkiss. Straight-line drive. Highly efficient, long wearing needle bearing type universal joints with two tubular propeller shafts supported by rubber-encased ball type center bearing.

FRAME. Truck-type pressed steel channel, extended at front for attachment of channel bumper. Frame 34 in. uniform width back of transmission. Side members: depth 6.0 in., width 2.25 in., thickness 0.19 in.

FRONT AXLE. Heat-treated alloy steel forgings. Tapered roller wheel bearings; roller or ball thrust bearings.

REAR AXLE. Full-floating type. Spiral bevel gear drive with straddle-mounted pinion. Ring gear thrust plate. Four-pinion type differential. Gear ratio: 4.86 to 1.

SPRINGS. Semi-elliptic. Special alloy steel. Front: length 36 in., width 1.75 in. forward end shackled. Rear: length 45 in., width 2.25 in. Hardened steel pins and steel-backed bronze bushings.

SHOCK ABSORBERS. Four. Direct, double-acting, telescopic design, with rubber insulated attachments.

STEERING. Heavy duty fore and aft truck type. Short, solid type drag link. Automatic type tie rod ends. Worm and needle bearing roller gear. Ratio 18.2 to 1. Wheel 3-spoke, 18 in. diam.

BRAKES. Hydraulic. Independently anchored, self-centering, two-shoe type, 12 in. x 1.75 in., front and rear. Lining area 167 sq. in. Brake drums demountable from hubs, with cast iron braking surfaces fused to pressed steel drum rings. Hand brake lever operates rear wheel brakes by cable control with equalizer.

WHEELS. Five, 16 x 6L. Heavy steel disc, 8-stud with wide base, drop center rims. 5° tapered bead seat. Hub caps at extra cost.

TIRES. Five. Size: std. 6.50-16 6-ply—opt. 7.00-16 6-ply; 7.50-16 6-ply (for max. G.V.W.).

TREAD. Front 58.08 inches. Rear 60 inches.

TURNING RADIUS. 22 ft. (right); 23 ft. (left).

TYPICAL EQUIPMENT. Includes front fenders; short running boards on Cab and Stake, long running boards on Express; rear fenders on Express; double-acting shock absorbers, front and rear; cowl ventilator; 20-gallon fuel tank in cab, 17-gallon in-frame fuel tank on chassis with cowl or windshield; spare wheel carrier at rear; spare wheel and spare tire; channel front bumper; jack and tool kit. R.H. windshield wiper and hub caps at extra cost.

FINISH. Frame, wheels, bumper and running boards black. Grille and recess Tucson Tan. Fenders, hood, cab and bodies in choice of eight Ford color options.

SERIES F-3

Max. Gross Vehicle Weight: 6,800 lbs.

Nominal Tonnage Rating:
3/4 Ton Heavy Duty

7 1/2 FT. PLATFORM STAKE
8 FT. EXPRESS

THE LIGHT DUTY TRUCK FOR BIG TRUCK LOADS

4-SPEED TRANSMISSION offers extra pulling ability in first gear, as much as 100% more than typical 3-speed transmission in some light trucks.

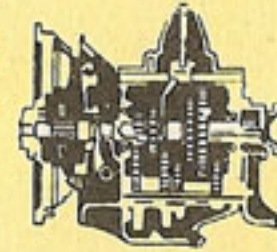

NEW MILLION DOLLAR CAB features new 3-Way Air Control. New coach-type seat for comfort. New Level Action cab mounting to frame for longer cab life. New Spiralounge floating seat with jumbo spiral coil spring and hydraulic shock absorber available for comfort-plus.

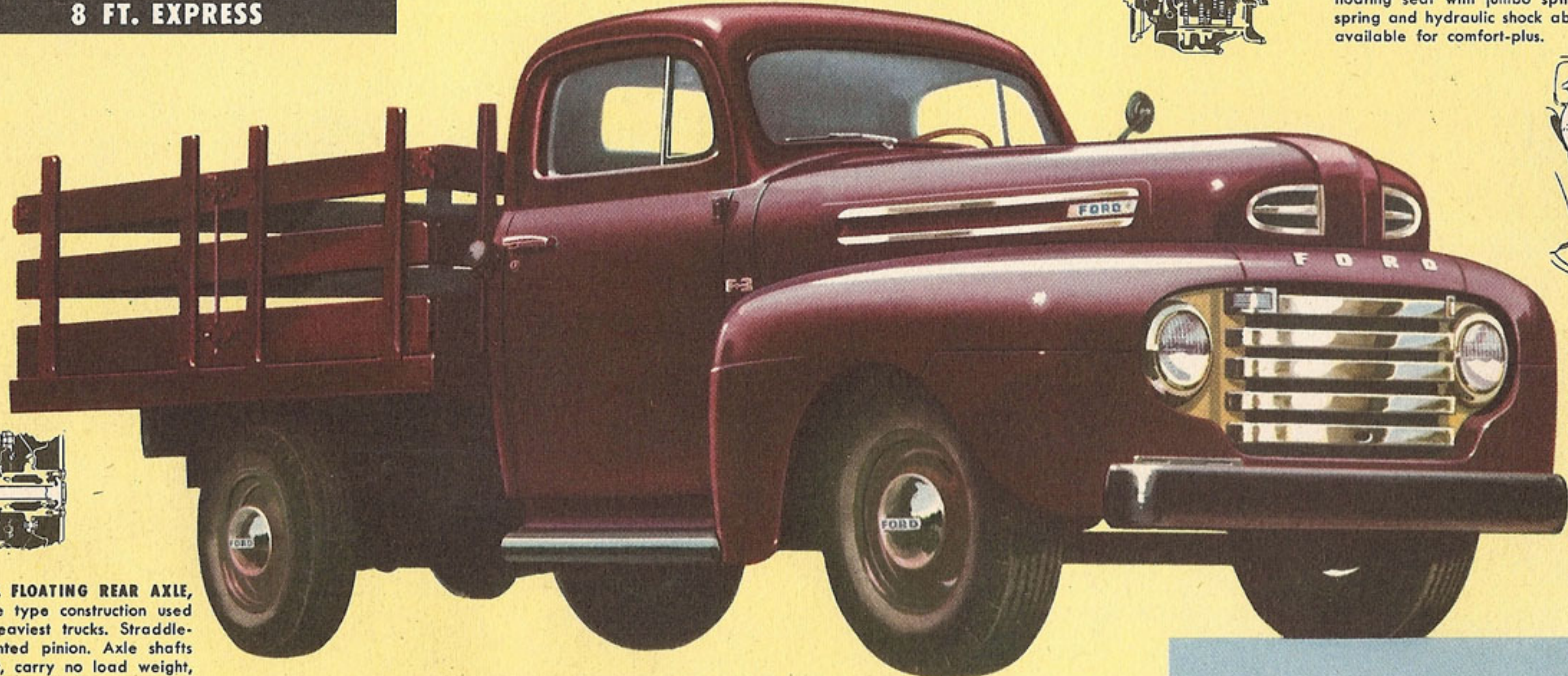

FULL FLOATING REAR AXLE, same type construction used in heaviest trucks. Straddle-mounted pinion. Axle shafts float, carry no load weight, are removable from wheel end.

HARDWOOD FLOORS rabbeted and firmly interlocked with long wearing steel skid strips. Floors and stake racks feature select hardwood from Ford's own hardwood forests.

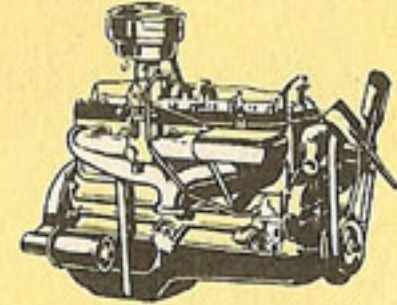
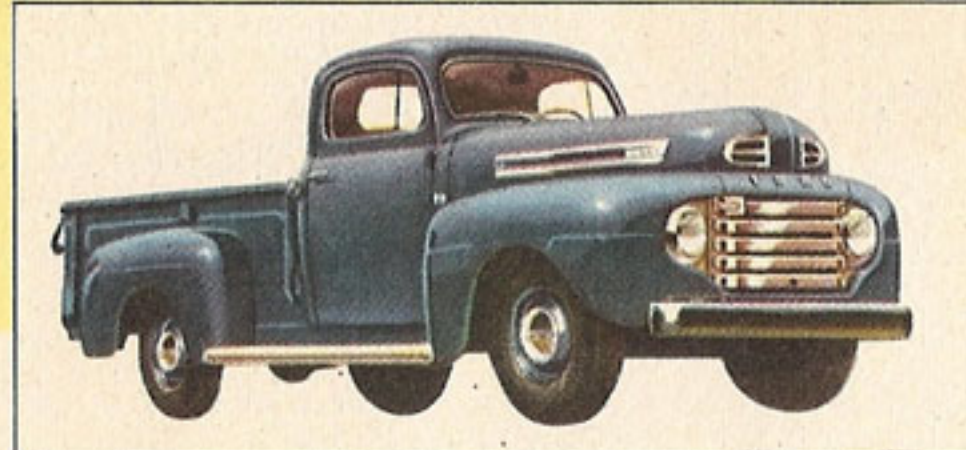
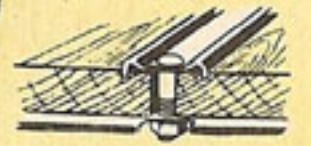

NEW ROUGE 226 TRUCK SIX. A true-truck engine from crankcase up. 95 horsepower. New oil-saver features. New gas-saver features. New advancements throughout. Low r.p.m. at road speeds used most.

RIGHT-HAND WINDSHIELD WIPER AND HUB CAPS AT EXTRA COST.

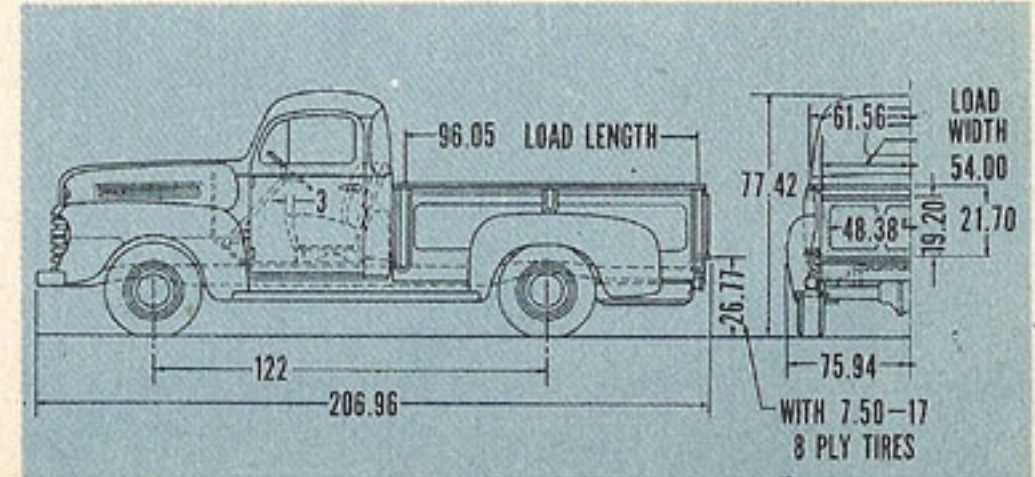
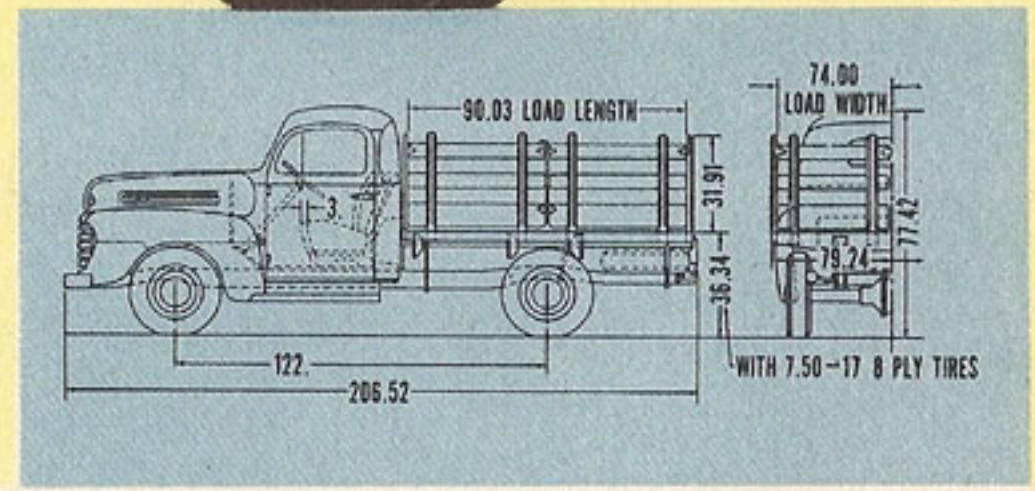

ENGINEERING HIGHLIGHTS—NEW F-3 STAKE OR EXPRESS

NEW ROUGE 226 TRUCK SIX—New, longer 4-ring Flightlight pistons save oil—Replaceable-type main and connecting rod bearings—Series-flow cooling with thermostatic control—Alloy exhaust valve seat inserts for longer wear—Improved intake manifold for higher efficiency—New Loadomatic spark control for more power, more economy. New Rouge 239 Truck V-8 available. **CHASSIS**—Feather-Foot brakes, fixed-anchor type, for easy stopping—New, removable brake drums facilitate servicing—Needle-bearing steering eases control—Flat tube and fin radiator for greater durability—Gyro-Grip clutch multiplies grip with increased speed—New, Airplane-type shock absorbers on front axle.

Actual payload capacity of the F-3 Express is near 1 1/2 tons. Its G.V.W. rating of 6,800 lbs., less curb weight of about 4,010 lbs. leaves a capacity of 2,790 lbs. for driver and load. The heavier Stake body reduces payload capacity only about 120 lbs. In high gear, the F-3 equipped with a 4.86 to 1 axle pulls its G.V.W. up a 7.6% smooth concrete grade. In first gear, a grade well over 30% can be attained. Engine speed at 35 m.p.h. is an economical 1,770 r.p.m. with the standard 4.86 axle.

TRUE FORD Bonus Built CONSTRUCTION

with big strength-reserves to handle big loads easily

RUBBER AXLE BUMPERS MINIMIZE SHOCK OF SPRING BOTTOMING

RUBBER-ENCASED CENTER BEARING FOR QUIET, LONG LIFE PERFORMANCE

ROUGE 226 TRUCK SIX: 95 H.P. (ROUGE 239 TRUCK V-8, 100 H.P., ALSO AVAILABLE)

NEW RUGGED BRACES FOR BETTER FENDER SUPPORT; HEAVIER, WIDER RUNNING BOARD AND BODY BRACKETS

UNIFORM 34-INCH FRAME WIDTH BACK OF TRANSMISSION

18-INCH DIAMETER STEERING WHEEL; 3-SPOKES, FOR BETTER INSTRUMENT VISIBILITY

OIL-BATH AIR CLEANER WITH DUST-PROOF CLAMP

LOADOMATIC IGNITION WITH FULL-AUTOMATIC VACUUM CONTROLLED DISTRIBUTOR

U-TYPE SUPPORT RELIEVES RADIATOR OF ROAD STRAINS

EXTRA LARGE 14-INCH BY 2-INCH REAR BRAKES

TUBULAR PROPELLER SHAFTS; LARGE DIAMETER; NON-WHIPPING

NEEDLE BEARING UNIVERSAL JOINTS FOR LONGER LIFE

CHANNEL BUMPER ATTACHED DIRECTLY TO EXTENDED FRAME GIVES GREATER PROTECTION, MORE RIGID FRAME

45 x 2 1/4 INCH SPRINGS WITH LONG LASTING, HARDENED STEEL PINS, STEEL-BACKED, BRONZE-BUSHED EYES

TIRE CARRIER, REAR MOUNTED

NEW STRAIGHT-THROUGH MUFFLER; LESS BACK PRESSURE, BETTER ENGINE PERFORMANCE

TRUCK-TYPE 4-SPEED TRANSMISSION

11-INCH GYRO GRIP CLUTCH MULTIPLIES GRIP WITH INCREASED SPEED

ENGINE MOUNTING RUBBER-CUSHIONED FOR LONG LIFE, SMOOTH OPERATION

DIRECT, DOUBLE-ACTING SHOCK ABSORBERS (FRONT) COMPLETELY SEALED

RUGGED, FLAT TUBE AND FIN RADIATOR

17-INCH DISC WHEELS, ADVANCED 2-PIECE WIDE BASE RIMS, 5° TAPERED BEAD SEAT, FOR LONGER TIRE LIFE

FULL FLOATING REAR AXLE WITH LOAD FREE AXLE SHAFTS

REMOVABLE BRAKE DRUMS, CAST IRON SURFACE FUSED TO STEEL BACK; HIGH STRENGTH, LOW WEIGHT

FRONT SPRINGS SHACKLED AT FORWARD END FOR MORE STABLE STEERING

I-BEAM AXLE REDESIGNED FOR NEW FORE AND AFT STEERING AND NEW SHOCK ABSORBERS

THE NEW SERIES F-3 TRUCK CHASSIS — 122-INCH WHEELBASE — 6,800 LBS. G. V. W.

CONDENSED SPECIFICATIONS:

ENGINE. 95 H.P. Six or 100 H.P. V-8.

CLUTCH. Semi-centrifugal type. Diameter 11 in. Total frictional area 123.7 sq. in.

TRANSMISSION. Heavy duty, 4 speed sliding gear type. Two-piece case design—with separate clutch housing. All gears forged from alloy steel, heat-treated. Roller and ball bearings in all forward speeds. Spring-loaded internal reverse lock. Countershaft thrust washers.

DRIVE LINE. Hotchkiss. Straight-line drive. Highly efficient, long wearing needle bearing type universal joints with two tubular propeller shafts supported by rubber encased ball type center bearing.

FRAME. Truck-type pressed steel channel, extended at front for attachment of channel bumper. Frame 34 in. uniform width back of transmission. Side members: depth 6.0 in., width 2.25 in., thickness 0.19 in.

FRONT AXLE. Heat-treated alloy steel forging. Tapered roller wheel bearings; roller or ball thrust bearings.

REAR AXLE. Full-floating type. Spiral bevel gear drive with straddle-mounted pinion. Ring gear thrust plate. Four-pinion type differential. Gear Ratio: 4.86 to 1.

SPRINGS. Semi-elliptic. Special alloy steel. Front: length 36 in., width 1.75 in., forward end shackled. Rear: length 45 in., width 2.25 in. Hardened steel pins and steel-backed bronze bushings.

SHOCK ABSORBERS. Direct, double-acting telescopic design on front with rubber insulated attachments.

STEERING. Heavy duty fore and aft truck type: Short, solid type drag link. Automatic type tie rod ends. Worm and needle bearing roller gear. Ratio 18.2 to 1. Wheel 3-spoke, 18 in. diam.

BRAKES. Hydraulic. Independently anchored, two shoe type. Front 12 in. x 1.75 in., rear 14 in. x 2 in. Lining area 188 sq. in. Brake drums demountable from hubs with cast iron braking surfaces fused to pressed steel drum rings. Hand brake lever operates rear wheel brakes by cable control with equalizer.

WHEELS. Five 17 x 5.5. Heavy steel disc, 8-stud with 2-piece, full advance, wide base rims. 5° tapered bead seat. Hub caps at extra cost.

TIRES. Five. Size: std. 7.00-17 6-ply—opt. for max. G.V.W. 7.00-17 6-ply front and 7.50-17 8-ply rear and spare.

TREAD. Front 58.08 inches. Rear 60 inches.

TURNING RADIUS. 22 ft. (right); 23 ft. (left).

TYPICAL EQUIPMENT. Includes front fenders; short running boards on Cab and Stake, long running boards on Express; rear fenders on Express; double-acting shock absorbers on front; cowl ventilator; 20-gallon fuel tank in cab, 17-gallon in-frame fuel tank on Chassis with cowl or windshield; spare wheel carrier at rear; spare wheel and spare tire; channel front bumper; jack and tool kit. R.H. windshield wiper and hub caps at extra cost.

FINISH. Frame, wheels, bumper and running boards black. Grille and recess Tucson Tan. Fenders, hood, cab and bodies in choice of eight Ford color options.

SERIES F-4

Max. Gross Vehicle Weight:
10,000 lbs. (with 7.00-18 duals) —
7,500 lbs. (with 7.00-20 singles)

Nominal Tonnage Rating: One Ton
9 FT. PLATFORM STAKE

A NEW MODEL WITH TRUE FORD QUALITY

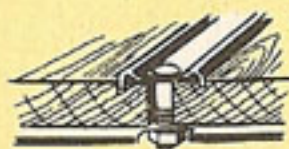

HARDWOOD FLOORS rabbeted and firmly interlocked with long-wearing steel skid strips. Floors and stake racks feature select hardwood.

NEW MILLION DOLLAR CAB features new 3-Way Air Control, new coach-type seat for comfort, new Level Action cab mounting to frame for longer cab life, new Spiralounge floating seat with variable rate coil spring and hydraulic shock absorber available for comfort-plus.

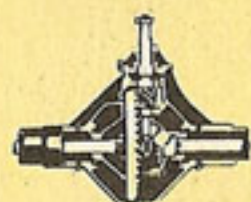
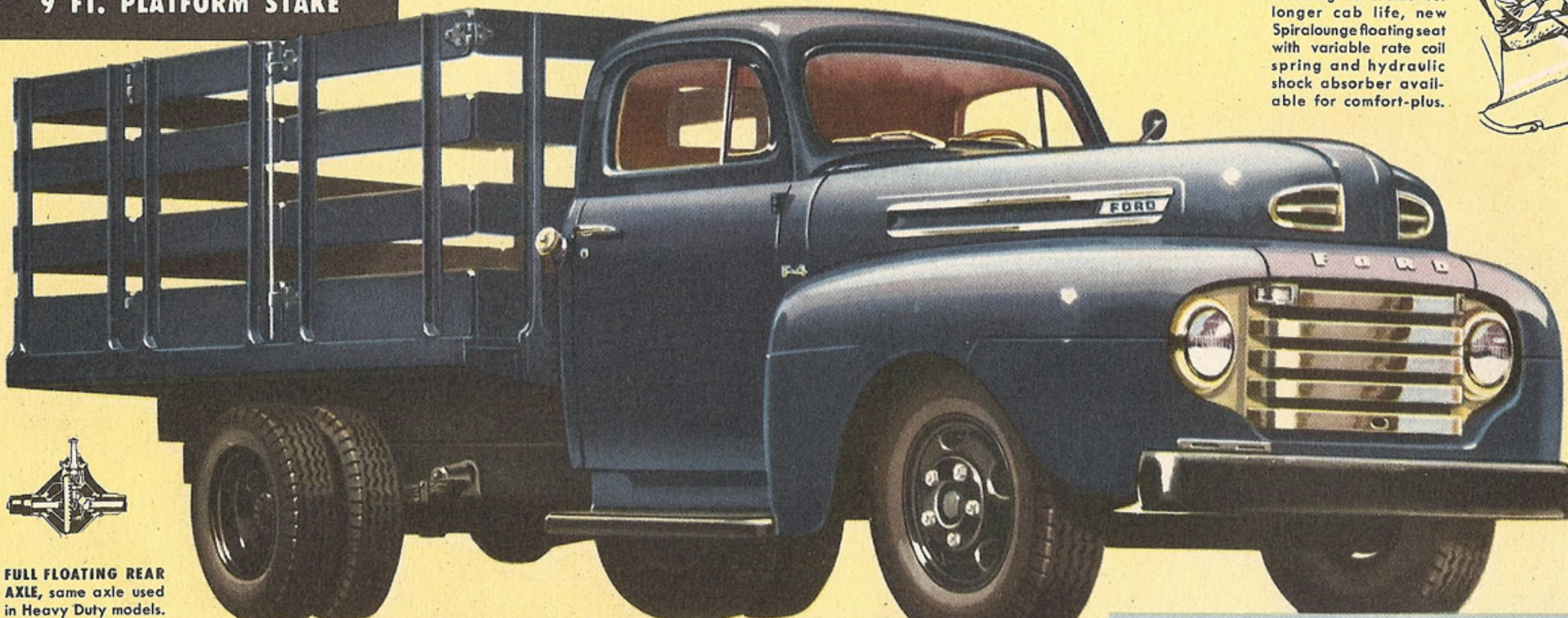

FULL FLOATING REAR AXLE, same axle used in Heavy Duty models. Straddle-mounted pinion. Axle shafts float, carry no weight load, are removable from wheel end.

RIGHT-HAND WINDSHIELD WIPER AT EXTRA COST.



18-INCH DUAL REAR WHEELS add carrying capacity, bring gross vehicle weight rating up to 10,000 lbs. with 7.00-18 tires. Advanced design 2-piece wide base rims with 5° tapered bead seat help prolong tire life.

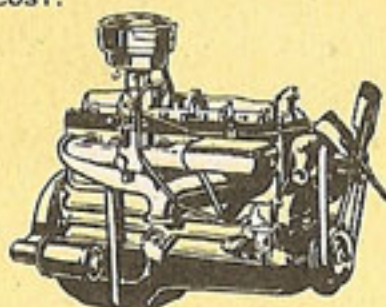

NEW ROUGE 226 TRUCK SIX. A true-truck engine from crankcase up. 95 horsepower. New oil-saver features. New gas-saver features. New advancements throughout. Low r.p.m. at road speeds used most.

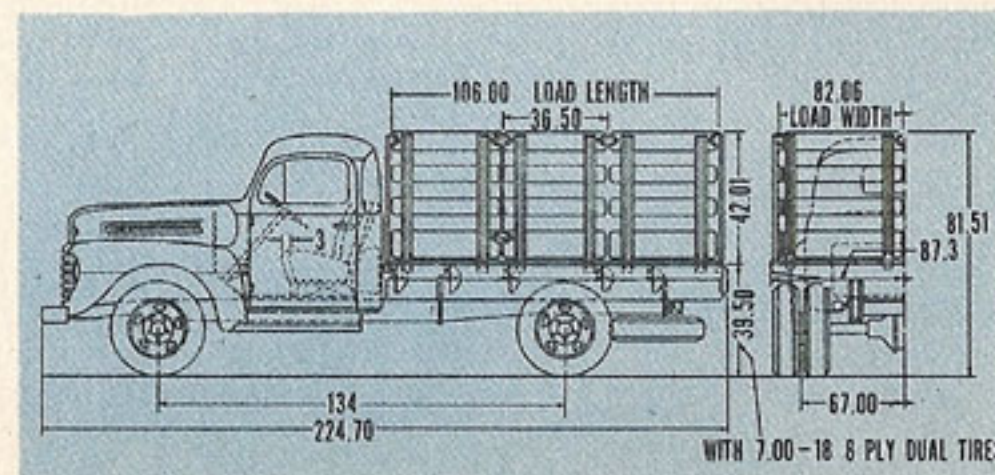
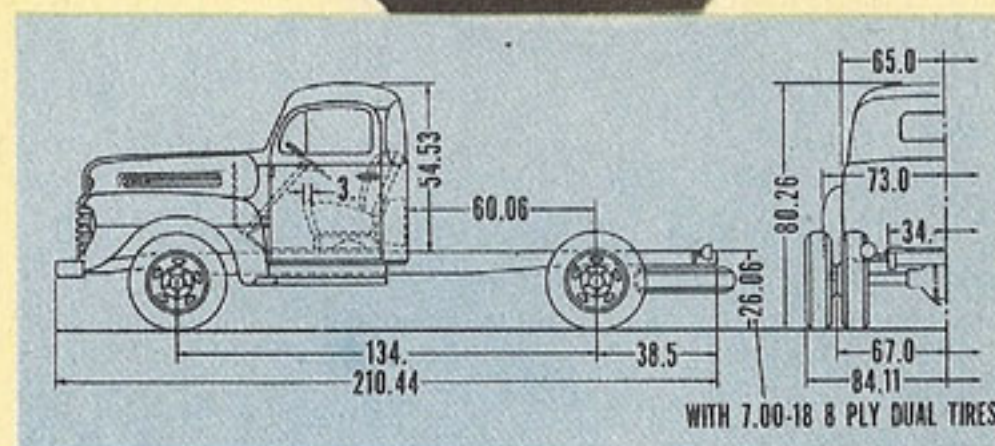

ENGINEERING HIGHLIGHTS—NEW F-4 STAKE OR PLATFORM

NEW ROUGE 226 TRUCK SIX—New, longer 4-ring Flightlight pistons save oil—Replaceable-type main and connecting rod bearings—Series-flow cooling with thermostatic control—Alloy exhaust valve seat inserts for longer wear—Improved intake manifold for higher efficiency—New Loadomatic spark control for more power, more economy. New Rouge 239 Truck V-8 available. **CHASSIS**—Feather-Foot hydraulic brakes, fixed-anchor type, for true and easy stopping—New, removable brake drums facilitate servicing—Strong 7-inch frame for big truck loads—Flat tube and fin radiator for greater durability—Roll-action needle bearing steering eases control—Gyro-Grip clutch multiplies grip with increased speed—Wide track, rugged, I-beam type front axle.

The F-4 is a big truck in every sense of the word. On 7.00-18 dual rear tires it is rated to carry a gross load of 10,000 lbs. This leaves body and payload capacity of 5,730 lbs. after deducting curb weight of chassis and cab. With a standard 5.14 axle ratio and 7.00-18 duals, the F-4 pulls a 5.2% smooth concrete grade in high gear with full 10,000 lbs. gross vehicle weight, and better than a 30% grade in first gear. At 35 m.p.h., engine speed is an economical 1,875 r.p.m. The 5.83 optional axle ratio boosts pulling ability approximately 13½%.

FULL BROTHER OF FORD "HEAVIES"

modified slightly for lighter delivery work and priced accordingly

HEAVY DUTY, FULL-FLOATING REAR AXLE—STRADDLE MOUNTED PINION

EXTRA LARGE 15-INCH BY 3½-INCH REAR BRAKES

TUBULAR PROPELLER SHAFTS; LARGE DIAMETER; NON-WHIPPING

18-INCH DIAMETER STEERING WHEEL; 3-SPOKES FOR BETTER INSTRUMENT VISIBILITY

LOADOMATIC IGNITION WITH FULL-AUTOMATIC VACUUM CONTROLLED DISTRIBUTOR

NEW RUGGED BRACES FOR BETTER FENDER SUPPORT; HEAVIER, WIDER RUNNING BOARD AND BODY BRACKETS

TIRE CARRIER, REAR MOUNTED

NEEDLE BEARING UNIVERSAL JOINTS FOR LONGER LIFE

ROLL-ACTION NEEDLE BEARING STEERING GEAR, 3-TEETH IN MESH

ROUGE 226 TRUCK SIX: 95 H.P. (ROUGE 239 TRUCK V-8, 100 H.P., ALSO AVAILABLE)

RUBBER-ENCASED CENTER BEARING FOR QUIET, LONG LIFE PERFORMANCE

OIL-BATH AIR CLEANER WITH DUST-PROOF CLAMP

U-TYPE SUPPORT RELIEVES RADIATOR OF ROAD STRAINS

RUGGED, FLAT TUBE AND FIN RADIATOR

7-INCH FRAME; ELASTIC LIMIT 40,000 LBS. PER SQ. IN. HEAVY CROSSMEMBERS

NEW STRAIGHT-THROUGH MUFFLER; LESS BACK PRESSURE, BETTER ENGINE PERFORMANCE

TRUCK-TYPE 4-SPEED TRANSMISSION

45 x 2½ INCH 10-LEAF SPRINGS WITH LONG LASTING HARDENED STEEL PINS STEEL-BACKED, BRONZE-BUSHED EYES

ENGINE MOUNTING RUBBER-CUSHIONED FOR LONG LIFE, SMOOTH OPERATION

18-INCH DUAL WHEELS OR 20-INCH SINGLES; ADVANCED DESIGN 2-PIECE WIDE BASE RIMS, 5° TAPERED BEAD SEAT FOR LONGER TIRE LIFE

REMOVABLE BRAKE DRUMS, CAST IRON SURFACE FUSED TO STEEL BACK; HIGH STRENGTH

11-INCH GYRO GRIP CLUTCH MULTIPLIES GRIP WITH INCREASED SPEED

WIDE-TRACK I-BEAM FRONT AXLE, SHORT TURNING RADIUS

CHANNEL BUMPER ATTACHED DIRECTLY TO EXTENDED FRAME GIVES GREATER PROTECTION, MORE RIGID FRAME

THE NEW SERIES F-4 TRUCK CHASSIS — 134-INCH WHEELBASE — 10,000 LBS. G. V. W.

CONDENSED SPECIFICATIONS:

ENGINE. 95 H.P. Six or 100 H.P. V-8.

CLUTCH. Semi-centrifugal type. Diameter 11 in. Total frictional area 123.7 sq. in.

TRANSMISSION. Heavy duty, 4-speed sliding gear type. Two piece case design—with separate clutch housing. All gears forged from alloy steel, heat-treated. Roller and ball bearings in all forward speeds. Spring-loaded internal reverse lock. Countershaft thrust washers.

DRIVE LINE. Straight-line drive. Highly efficient, long wearing needle bearing type universal joints with two tubular propeller shafts supported by rubber-encased ball type center bearing.

FRAME. Heavy duty pressed steel channel, extended at front for attachment of channel bumper. Frame 34 in. uniform width back of transmission. Side members: depth 7 in., width 2.75 in., thickness 0.21 in.

FRONT AXLE. Modified I-beam type, heat-treated alloy steel forging. Large spindles, tapered roller wheel bearings; roller or ball thrust bearings.

REAR AXLE. Full-floating type. Spiral bevel gear drive with straddle-mounted pinion. Ring gear thrust plate. Four-pinion type differential. Gear ratios: std. 5.14 to 1—opt. 5.83 to 1.

SPRINGS. Special alloy steel. Front: length 36 in., width 2 in., forward shackled with safety eyes. Rear: length 45 in., width 2.5 in., 10 leaves. Bronze bushed eyes.

STEERING. Solid type drag link and automatic type tie rod ends equipped with dust shields. Worm and dual needle bearing type gear with three tooth roller. Ratio 20.4 to 1. Wheel 3-spoke, 18 in. diam.

BRAKES. Service: Hydraulic, independently anchored two-shoe type. Front: 14 in. x 2 in., rear 15 in. x 3.5 in. Lining area 302 sq. in. Cast iron brake drums fused to steel drum discs, demountable from hubs. Hand brake: 7.81 in. x 2.5 in. on drive shaft.

WHEELS. Tapered steel disc, 5-stud, with 2-piece, full advance, wide base rims. 5° tapered bead seat. Five 20 x 5.0 standard for single tires—seven 18 x 5.0 optional for dual tires.

TIRES. Standard: four, 7.00-20 8-ply, front and single rear. Optional for max. G.V.W.: six, 7.00-18 8-ply, front and dual rear.

TREAD. Front 60.03 in. Rear: singles 57½ in., duals 67 in.

TURNING RADIUS. 21.5 ft. (right); 24 ft. (left).

TYPICAL EQUIPMENT. Includes front fenders; short running boards on Cab and Stake; cowl ventilator; 20-gallon fuel tank in cab, 25-gallon fuel tank mounted outside left frame rail on chassis without cab; spare wheel carrier; spare wheel; channel front bumper; jack and tool kit. R.H. windshield wiper at extra cost.

FINISH. Frame, wheels, bumper and running boards black. Grille and recess Tucson Tan. Fenders, hood, cab and body in choice of eight Ford color options.

SPECIAL TRUCK EQUIPMENT AND ACCESSORIES

Available at extra cost

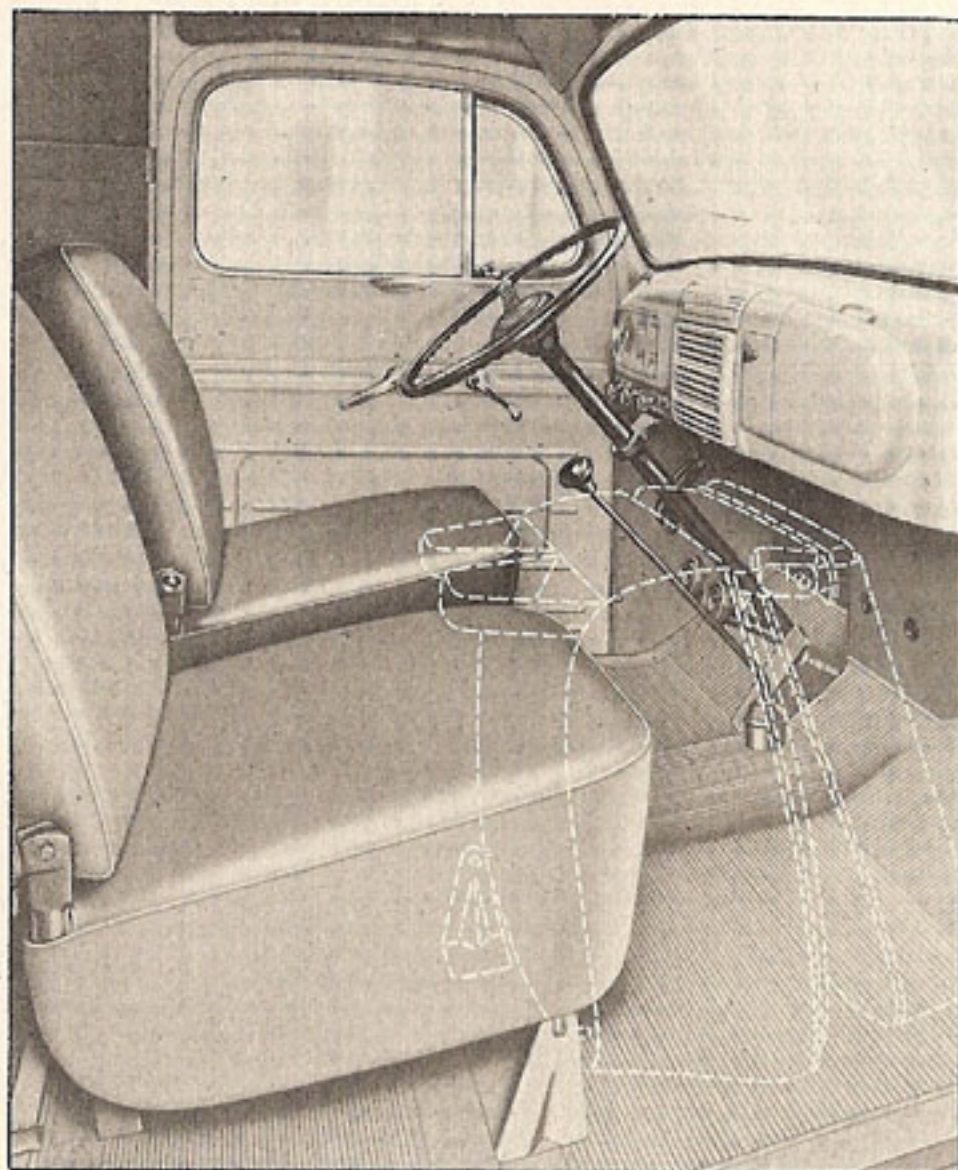

▲ Folding-type **PASSENGER SEAT** is available for right-hand side of panel body. Matches standard driver's seat.

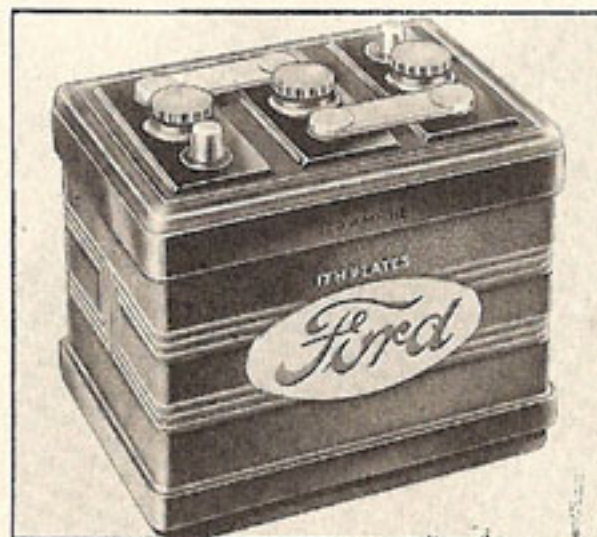

▲ **120 AMP. BATTERY** for longer life in hard service. Standard truck battery is 100 ampere hour battery.

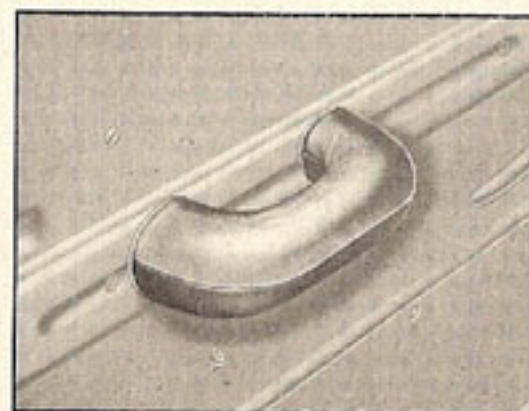

▲ **ARM REST**, properly positioned for maximum driving comfort.

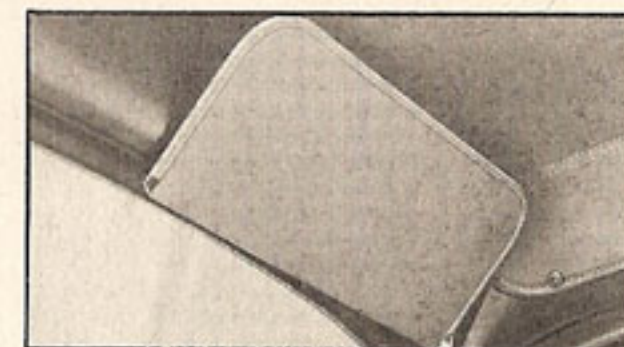

▲ **SUN VISOR** for right side; visor on left standard.

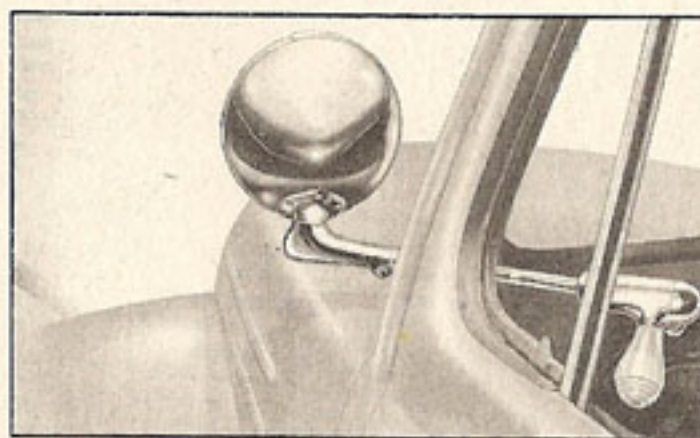

▲ **Ford SPOTLIGHT** throws strong penetrating beam. Switch conveniently located.

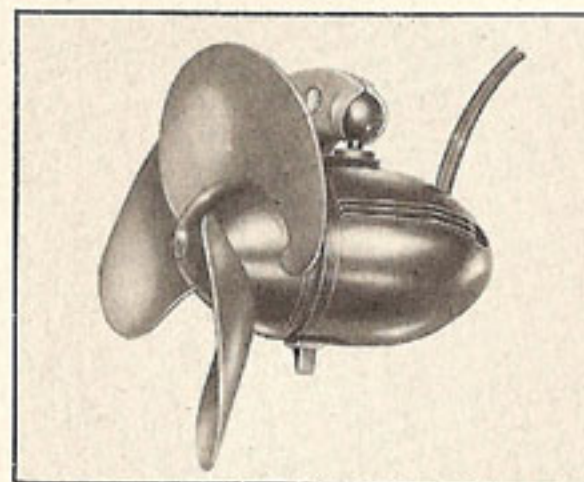

▲ **DEFROSTER FAN** helps keep windshield clear for safer driving.

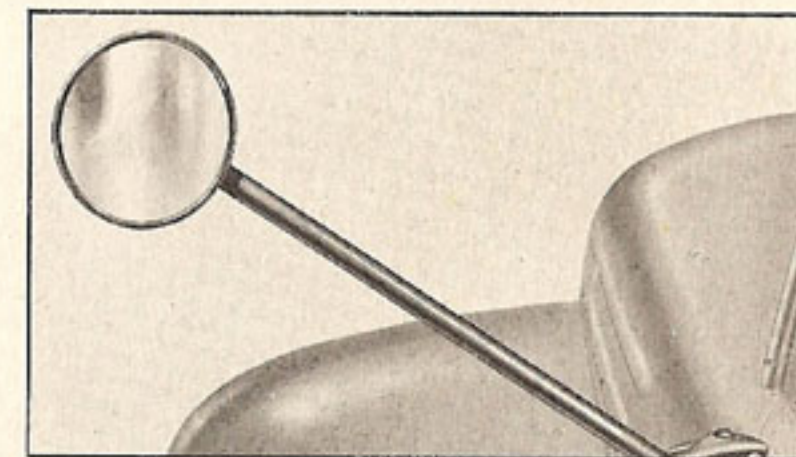

▲ **LONG ARM MIRROR**, adjustable type, for better rear view with maximum width bodies.

▲ Hot water **HEATER-DEFROSTER** has two-speed direct heat flow for quick warm-up; two speed indirect flow for continuous driving.

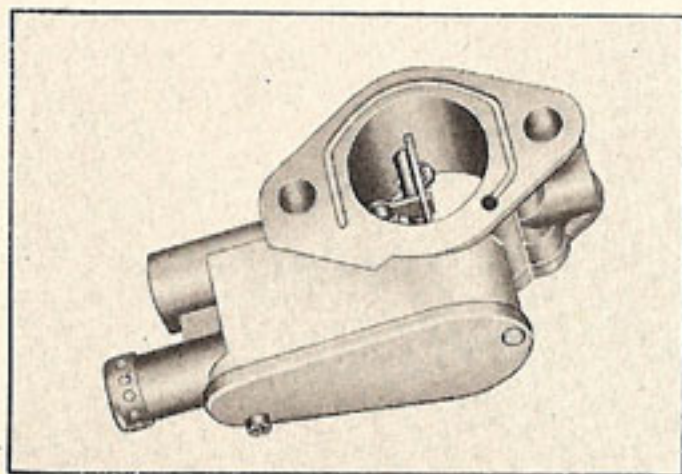

▲ **GOVERNOR** guards against excessive engine and road speeds. Set 1200 to 3000 r.p.m.

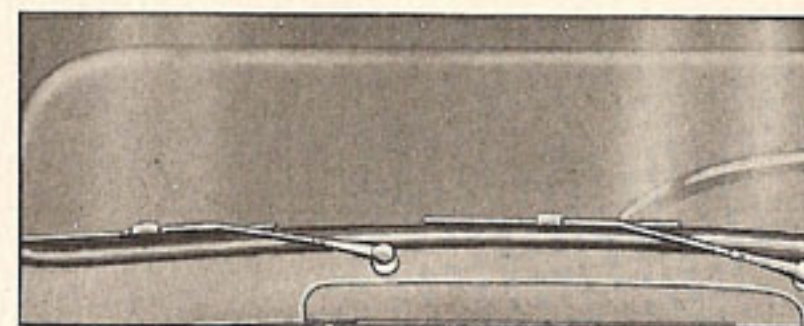
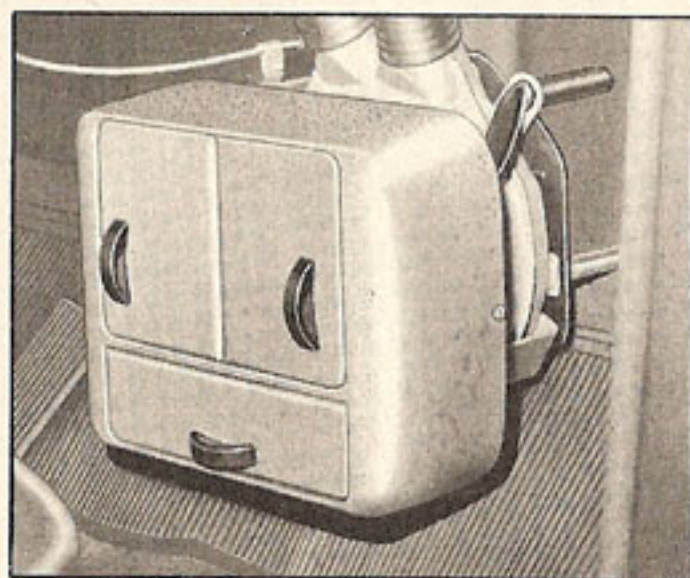

▲ **WINDSHIELD WIPER** for right-hand side of cab or driver's compartment; left-hand wiper standard.

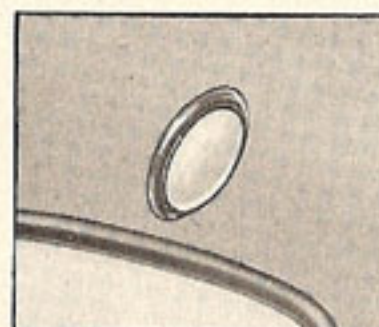

▲ **DOMELIGHT** is available in Ford cabs.

FOR OTHER TRUCK EQUIPMENT AND ACCESSORIES

Consult Your Ford Dealer

Windshield washers, radiator overflow tank, short running boards for flat face cowl and windshield cowl, 135 ampere hour battery, locking gas tank cap, fog lights, trouble light, brake fluid reservoir, lubricator gun, tire pump, heavy duty fan, right side tail and stop lamp, cigarette lighter, 11-inch clutch with 4-speed transmission (for F-1), and other special equipment and accessories can be obtained through your friendly Ford Dealer.

FORD *Bonus Built* CHASSIS SPECIFICATIONS

LIGHT DUTY MODELS

SERIES	F-1	F-2	F-3	F-4
NOMINAL RATING	½-Ton	¾-Ton	¾-Ton H.D.	1-Ton
MAX. GROSS VEHICLE WEIGHT RATING	4700 lbs.	5700 lbs.	6800 lbs.	7500 lbs. (single tires) 10000 lbs. (dual tires)
REAR TIRE SIZE FOR MAX. G.V.W.	6.50-16 6-ply	7.50-16 6-ply	7.50-17 8-ply	7.00-20 8-ply single 7.00-18 8-ply dual
AXLE, FRONT				3900 lbs.
Capacity	2500 lbs.			
Size (Height x Width x Web)	2.29" x 1.6" x 0.24"			2.50" x 1.83" x 0.33"
Thrust Bearing	Tapered Roller or Anti-friction Ball			
Wheel Bearings	High Capacity Dual Opposed Adjustable Tapered Roller			
Tie Rod	Ball Stud and Socket, Spring Loaded for Automatic Take-up of Wear, Equipped with Rubber Dust Shields			
AXLE, REAR				10800 lbs.
Type	Hypoid—½-Fl.	Spiral Bevel—Full Floating		
Capacity	3000 lbs.	4000 lbs.	5000 lbs.	
Pinion Mounting	Overhung	Straddle-Mounted		
Differential	2-Pinion	4-Pinion		
Axle Shaft Diam. at Spline	1.25"	1.37"		1.75"
Pinion and Differential Bearings	Tapered Roller	Dual Opposed Tapered Roller (pinion inboard and differential case)—Straight Roller (pinion outboard)		
Wheel Bearings	Sealed Ball	High Capacity, Dual Opposed, Adjustable Tapered Roller		
Axle Ratios (to 1)	3.73 or 4.27	4.86		5.14 or 5.83
Size—Front	11" x 2"	12" x 1.75"		14" x 2"
Rear	11" x 1.75"	12" x 1.75"	14" x 2"	15" x 3.5"
Total Lining Area, Sq. In.	178	167	188	302
Total Drum Area, Sq. In.	259	264	308	506
BRAKES, SERVICE (Hydraulic)	Cable with Equalizer applying Rear Wheel Brakes			Drum on Drive Shaft
CLUTCH (Gyro-grip)				7.81" x 2.5"
Diameter	10"	11"		
Friction Area, Sq. In.	85.5	123.7		
Plate Pressure lbs.: Zero Speed vs. 3000 R.P.M.	1089-1669	1044-1439		
Pedal Pressure, lbs.: Zero Speed vs. 3000 R.P.M.	31-45	34-45		
DRIVE LINE	Hotchkiss, Straight-line Drive, Open Tubular Propeller Shaft(s) and Needle Bearing Universal Joints. Ball Center Bearing on 122" wb. and 134" wb.			
FRAME	Size (Depth x Flange x Thick.)			7" x 2.75" x 0.21"
	5.92" x 2.25" x 0.15"	6.0" x 2.25" x 0.19"		
STEERING GEAR	Section Modulus			5.23
	2.65	3.34		
SPRINGS, FRONT	Ratio			20.4 to 1
	18.2 to 1			
	Steering Wheel			
	18-Inch Diam. 3-Spoke Type, Serrated Hub for Positioning on Shaft			
	Size (Length x Width)			36" x 2"
	36" x 1.75"			
	No. of Leaves—Deflection Rate, Lbs. per In.	8-243	8-423	11-673
	Capacity (At Normal Deflection)—per Spring	850 lbs.	1025 lbs.	1375 lbs.
SPRINGS, REAR	Size (Length x Width)			45" x 2.5"
	45" x 2"			
	No. of Leaves—Deflection Rate, Lbs. per In.	10-275*	12-465	13-520
	Capacity (At Normal Deflection)—per Spring	1350 lbs.*	1950 lbs.	2400 lbs.
SHOCK ABSORBERS	Front			
	Direct—Double Acting—Telescopic			
	Rear			
	Direct—Double Acting—Telescopic			
TRANSMISSION	Type			4-Speed Sliding Gear
	3-Speed Helical Syn.			
	Gear Ratios (to 1)			6.40
	2.819			3.09
	Second			1.685
	1.604			Direct
	Third			7.825
	Direct			
	Fourth			
	3.625			
WHEELS AND RIMS	Number—Size: Standard			5—20 x 5.0
	5—16 x 4½ K			5—20 x 5.0
	Optional			7—18 x 5.0
	None			5
	Studs			
	5			
	Wide Base Rim Type			
	Drop Center			RH 5° 2-Piece Advance
TIRES	Size: Standard			7.00-20 8-p. F. & R.
	6.00-16 4-p. F. R. & S.			7.00-17 6-p. F. R. & S.
	6.50-16 6-p. F. R. & S.			7.00-17 6-p. Front and 7.50-17 8-p. Rear & Spare
	7.00-16 6-p. F. R. & S.			7.00-18 8-p. F. & D. R.
	Sizes Available in Production			

F = Front. R = Rear. S = Spare. D = Dual.

*Rear Springs on Panel: 9 leaves—rate 230 lbs. per in., Capacity 1,050 lbs.

BUILT STRONGER TO LAST LONGER

ENGINE SPECIFICATIONS

NEW ROUGE 226 TRUCK SIX

95 HORSE POWER. Bore 3.300 in. Stroke 4.400 in. Piston displacement 226 cu. in. Brake horsepower 95 at 3300 r.p.m. Max. torque 180 lb.-ft. at 1200 r.p.m. Comp. ratio 6.8 to 1.

BLOCK. One-piece cylinder casting in unit with crankcase of Ford alloy iron. Cylinder bores controlled quality micro-finish for uniform oil film. Full length water jackets.

HEAD. Turbulent-type high compression, Ford cast alloy iron.

CRANKSHAFT. Ford cast alloy steel, counterbalanced, with viscous or rubber-bonded vibration damper. Weight 73 lbs. Four large main bearings, steel-backed special Ford alloy, locked-in, precision, replaceable type. Total bearing area—43.385 sq. in.

CONNECTING RODS. Heat-treated steel forgings with locked-in, steel-backed copper lead, precision, replaceable bearings. Bronze piston pin bushings.

PISTONS. Ford Flightlight cam ground aluminum alloy, plated finish, with four rings above pin. Full-floating tubular piston pins.

CAMSHAFT. High-lift, special cast alloy iron, gear-driven from crankshaft for precise timing. Precision-machined aluminum timing gear.

VALVES. Special heat-resisting alloy steel. Self-locking screw style tappets. Long, pressed-in valve guides. Shot-blasted, rust-proofed valve springs. Special chrome-molybdenum steel exhaust valve seat inserts.

LUBRICATION. Full pressure to all main, connecting rod and camshaft bearings. Large capacity rotor type pump, gear driven from center of camshaft. Base mounted replaceable cartridge oil filter. Truck type oil pan with detachable plate for screen removal and pan clean-out. Directed-flow crankcase ventilation. Crankcase capacity, 5 quarts.

COOLING. Series-flow system providing increased water velocity and closer temperature control. High capacity, centrifugal, packless, pre-lubricated pump. Recirculation type thermostatic water temperature control. Fan 4-blade, 17 in. diam. Flat tube and fin radiator, pressure cap.

FUEL SYSTEM. Balanced downdraft carburetor with four-port, advanced type, shielded intake manifold. Automatic riser heat control. Oil bath air cleaner with seal-tight V-clamps. Mechanical fuel pump with sediment bowl.

IGNITION. Loadomatic system with fully automatic vacuum controlled distributor, driven from camshaft. Metal-clad coil mounted adjacent to distributor. Open type wiring, secured by rubber grommets.

ELECTRICAL. Air-cooled, heavy duty generator, 230 watts, 30-33 amperes. High torque starter, automatic engagement, solenoid switch, push button control. Ford heavy duty 17 plate, 100 ampere hour battery.

MOUNTING. Three-point cushion-type engine suspension.

NEW ROUGE 239 TRUCK V-8

90° L-head type. Bore 3.1875 in., stroke 3.75 in., piston displacement 239 cu. in. Max. B.H.P. 100 at 3800 r.p.m.; max. torque 180 lbs.-ft. at 2000 r.p.m. Comp. ratio 6.8 to 1. One piece casting of cylinders and upper crankcase. Head with high turbulence combustion chambers. Crankshaft Ford cast alloy steel, fully counterbalanced. Flightlight pistons, aluminum alloy, cam ground, 4 rings each. Individual locked-in, steel-backed copper lead connecting rod bearings. Valves precision-set; special chrome-molybdenum steel intake and exhaust valve seat inserts. Series-flow engine cooling system; two self-lubricating, packless pumps. Direct pressure lubrication; removable plate in oil pan; dual downdraft carburetion; horizontal plane duplex intake manifold; Loadomatic ignition with fully automatic vacuum controlled spark advance.

BODY SPECIFICATIONS

PICKUP AND EXPRESS. Welded steel construction with reinforced side panels. Heavy corner posts welded to body sides. Four stake pockets on Pickup, six on Express. Flareboards and front panel have reinforced rolled-edge. Tailgate strengthened with tapered truss-type rolled-edge. Anti-rattle drop chains clamp tailgate tightly to body sides when closed or hold tailgate flush with floor when open. Full height reinforced front panel. Pickup has steel floor with integral skid strips and supporting hardwood sub-floor. Express provided with interlocked hardwood floor protected by steel skid strips.

DIMENSIONS	6½ FT. PICKUP	8 FT. EXPRESS
Load space: length x width.....	78" x 49.0"	96" x 54.0"
(between wheelhouses).....		48.38 in.
Heights: floor to top of tailgate and to top of flare	17.56"-20.11"	19.2"-21.70"
Capacity	45 cu. ft.	62.4 cu. ft.

STAKES. Bridge-type body-frame construction. Steel side rails riveted to cross girders. Body sills fastened to steel cross girders with large steel brackets. Heavy hardwood floor interlocked over joints by steel skid strips bolted to cross girders providing a sealed, warp-proof floor. Steel stake pockets riveted and welded to side rails. Rear sill ends steel capped. Removable hardwood stake sections with straight-grained hardwood stakes; one-piece sides and ends on 6½-ft. body, two-piece hinged sides with one-piece front end, and two-piece rear end on 7½ ft. body. Removable stake sections, with hardwood rack boards riveted to rigid "U"-shaped steel stakes; three-piece sides with hinged center section, one-piece front, two-piece rear sections on 9 ft. body. Steel interlocks provided at top corners.

DIMENSIONS	6½-FT. STAKE	7½-FT. STAKE	9-FT. STAKE
Load space: length x width.....	80" x 67"	90" x 74"	106" x 82"
Height of stakes.....	29.54"	31.91"	42.01"

PANEL. Reinforced construction, with side panels and steel top panels shaped and welded together for rigidity and high strength. Body sides double-sealed at floor with felt and rubber. Solid plywood floor protected by steel skid strips. Steel paneling protects sides from floor to top of wheelhouses. Rear fenders integral with body side panels. Rear doors hung in one-piece channel steel frame, fitted with soft rubber seals. Two-position rear door checks—90° or full open, independent rear door lock. Safety glass throughout, fully weather-stripped windows with air wing door ventilators. Cowl ventilator. Bucket type driver's seat, 3-inch adjustment. Interior light. Sun visor, windshield wiper, exterior arm mirror. Front and rear channel bumpers standard.

DIMENSIONS	8-FT. PANEL
Load space: length x width x height.....	95.4" x 60.0" x 55.43"
Rear opening—width x height.....	48.0" x 46.7"
Total capacity (including space at right of driver)	160.3 cu. ft.

Ford Motor Company, Dearborn, Michigan

FORD TRUCKS LAST UP TO 19.6% LONGER

THE FORD MOTOR COMPANY, WHOSE POLICY IS ONE OF CONTINUOUS IMPROVEMENT, RESERVES THE RIGHT TO CHANGE AT ANY TIME, SPECIFICATIONS, DESIGN OR PRICES WITHOUT INCURRING OBLIGATION. FORD MOTOR COMPANY, DEARBORN, MICHIGAN

C. E. Johnson Motor Sales
725 W. Broadway
MINNEAPOLIS - MINN.